



UCAT

# HTR-5140

*Natural Sound AV Receiver*

*Ampli-Tuner Audio-Video*

**OWNER'S MANUAL  
MODE D'EMPLOI**

# SAFETY INSTRUCTIONS

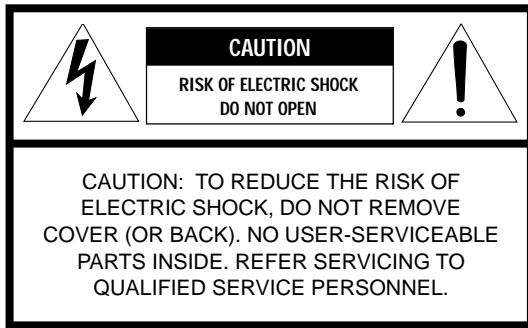

• Explanation of Graphical Symbols

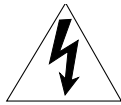

The lightning flash with arrowhead symbol, within an equilateral triangle, is intended to alert you to the presence of uninsulated "dangerous voltage" within the product's enclosure that may be of sufficient magnitude to constitute a risk of electric shock to persons.



The exclamation point within an equilateral triangle is intended to alert you to the presence of important operating and maintenance (servicing) instructions in the literature accompanying the appliance.

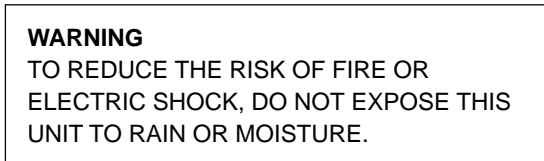

- 1 Read Instructions – All the safety and operating instructions should be read before the unit is operated.
- 2 Retain Instructions – The safety and operating instructions should be retained for future reference.
- 3 Heed Warnings – All warnings on the unit and in the operating instructions should be adhered to.
- 4 Follow Instructions – All operating and other instructions should be followed.
- 5 Water and Moisture – The unit should not be used near water – for example, near a bathtub, washbowl, kitchen sink, laundry tub, in a wet basement, or near a swimming pool, etc.
- 6 Carts and Stands – The unit should be used only with a cart or stand that is recommended by the manufacturer.
- 6A A unit and cart combination should be moved with care. Quick stops, excessive force, and uneven surfaces may cause the unit and cart combination to overturn.
- 7 Wall or Ceiling Mounting – The unit should be mounted to a wall or ceiling only as recommended by the manufacturer.



- 8 Ventilation – The unit should be situated so that its location or position does not interfere with its proper ventilation. For example, the unit should not be situated on a bed, sofa, rug, or similar surface, that may block the ventilation openings; or placed in a built-in installation, such as a bookcase or cabinet that may impede the flow of air through the ventilation openings.
- 9 Heat – The unit should be situated away from heat sources such as radiators, stoves, or other appliances that produce heat.
- 10 Power Sources – The unit should be connected to a power supply only of the type described in the operating instructions or as marked on the unit.
- 11 Power-Cord Protection – Power-supply cords should be routed so that they are not likely to be walked on or pinched by items placed upon or against them, paying particular attention to cords at plugs, convenience receptacles, and the point where they exit from the unit.
- 12 Cleaning – The unit should be cleaned only as recommended by the manufacturer.
- 13 Nonuse Periods – The power cord of the unit should be unplugged from the outlet when left unused for a long period of time.
- 14 Object and Liquid Entry – Care should be taken so that objects do not fall into and liquids are not spilled into the inside of the unit.
- 15 Damage Requiring Service – The unit should be serviced by qualified service personnel when:
  - A. The power-supply cord or the plug has been damaged; or
  - B. Objects have fallen, or liquid has been spilled into the unit; or
  - C. The unit has been exposed to rain; or
  - D. The unit does not appear to operate normally or exhibits a marked change in performance; or
  - E. The unit has been dropped, or the cabinet damaged.
- 16 Servicing – The user should not attempt to service the unit beyond those means described in the operating instructions. All other servicing should be referred to qualified service personnel.
- 17 Power Lines – An outdoor antenna should be located away from power lines.
- 18 Grounding or Polarization – Precautions should be taken so that the grounding or polarization is not defeated.

**19 For US customers only:**

Outdoor Antenna Grounding – If an outside antenna is connected to this unit, be sure the antenna system is grounded so as to provide some protection against voltage surges and built-up static charges. Article 810 of the National Electrical Code, ANSI/NFPA 70, provides information with regard to proper grounding of the mast and supporting structure, grounding of the lead-in wire to an antenna discharge unit, size of grounding conductors, location of antenna discharge unit, connection to grounding electrodes, and requirements for the grounding electrode.

**Note to CATV system installer:**

This reminder is provided to call the CATV system installer's attention to Article 820-40 of the NEC that provides guidelines for proper grounding and, in particular, specifies that the cable ground shall be connected to the grounding system of the building, as close to the point of cable entry as practical.

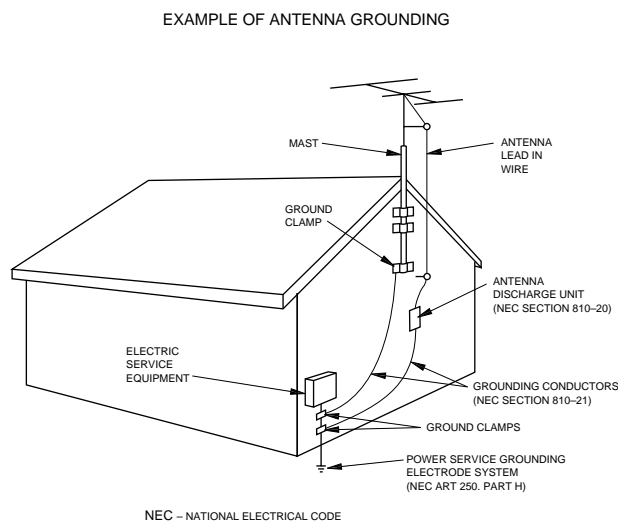

**FCC INFORMATION (for US customers only)**

**1. IMPORTANT NOTICE : DO NOT MODIFY THIS UNIT!**

This product, when installed as indicated in the instructions contained in this manual, meets FCC requirements. Modifications not expressly approved by Yamaha may void your authority, granted by the FCC, to use the product.

**2. IMPORTANT :** When connecting this product to accessories and/or another product use only high quality shielded cables. Cable/s supplied with this product **MUST** be used. Follow all installation instructions. Failure to follow instructions could void your FCC authorization to use this product in the USA.

**3. NOTE :** This product has been tested and found to comply with the requirements listed in FCC Regulations, Part 15 for Class "B" digital devices. Compliance with these requirements provides a reasonable level of assurance that your use of this product in a residential environment will not result in harmful interference with other electronic devices.

This equipment generates/uses radio frequencies and, if not installed and used according to the instructions found in the users manual, may cause interference harmful to the operation of other electronic devices.

Compliance with FCC regulations does not guarantee that interference will not occur in all installations. If this product is found to be the source of interference, which can be determined by turning the unit "OFF" and "ON", please try to eliminate the problem by using one of the following measures:

Relocate either this product or the device that is being affected by the interference.

Utilize power outlets that are on different branch (circuit breaker or fuse) circuits or install AC line filter/s.

In the case of radio or TV interference, relocate/reorient the antenna. If the antenna lead-in is 300 ohm ribbon lead, change the lead-in to coaxial type cable.

If these corrective measures do not produce satisfactory results, please contact the local retailer authorized to distribute this type of product. If you can not locate the appropriate retailer, please contact Yamaha Electronics Corp., U.S.A. 6660 Orangethorpe Ave, Buena Park, CA 90620.

The above statements apply **ONLY** to those products distributed by Yamaha Corporation of America or its subsidiaries.

**We Want You Listening For A Lifetime**

YAMAHA and the Electronic Industries Association's Consumer Electronics Group want you to get the most out of your equipment by playing it at a safe level. One that lets the sound come through loud and clear without annoying blaring or distortion – and, most importantly, without affecting your sensitive hearing.

Since hearing damage from loud sounds is often undetectable until it is too late, YAMAHA and the Electronic Industries Association's Consumer Electronics Group recommend you to avoid prolonged exposure from excessive volume levels.



**SUPPLIED ACCESSORIES**  
**ACCESSOIRES FOURNIS**

- After unpacking, check that the following parts are included.
- Après le déballage, vérifier que les pièces suivantes sont incluses.

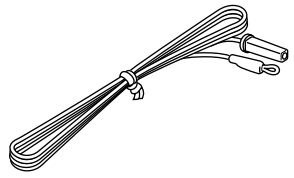
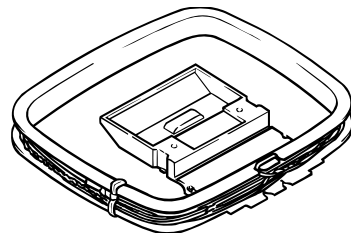
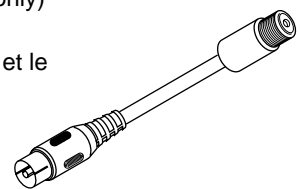
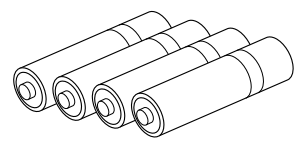
<ul style="list-style-type: none"> <li>• Indoor FM Antenna</li> <li>• Antenne FM intérieure</li> </ul>	
<ul style="list-style-type: none"> <li>• AM Loop Antenna</li> <li>• Cadre-antenne AM</li> </ul>	
<ul style="list-style-type: none"> <li>• Antenna adapter (U.S.A. and Canada models only)</li> <li>• Adaptateur d'antenne (Modèles pour les Etats-Unis et le Canada seulement)</li> </ul>	
<ul style="list-style-type: none"> <li>• Batteries (size AAA, R6, UM-4)</li> <li>• Piles (taille AAA, R6, UM-4)</li> </ul>	

- Remote control transmitter
- Télécommande

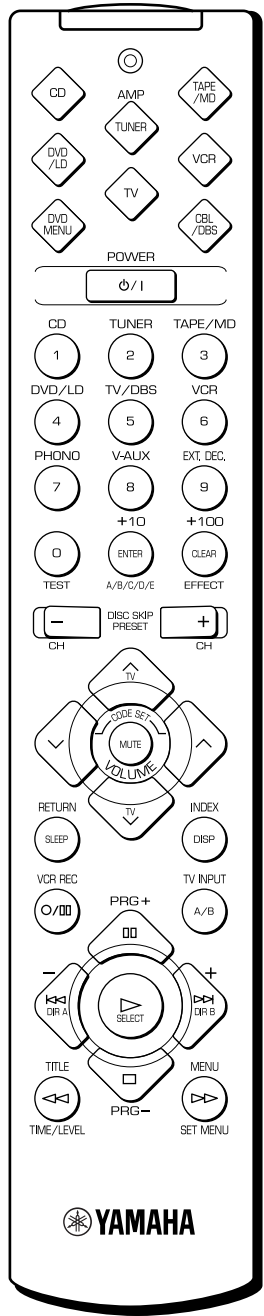

The remote control transmitter is a long, rectangular device with a variety of buttons. At the top, there is a power button and several function buttons including CD, AMP, TAPE/MD, DVD/LD, TUNER, VCR, and CBL/DBS. Below these are buttons for DVD MENU, TV, and POWER. The main section of the remote features a numeric keypad (0-9), a 0 button, and buttons for TEST, ENTER, and EFFECT. Below the numeric keypad are buttons for DISC SKIP/PRESET and CH. The center of the remote has a directional pad with TV, POWER SET, MUTE, and VOLUME buttons. Below this are RETURN, SLEEP, VCR REC, PRG+, TV INPUT, and A/B buttons. The bottom section includes buttons for DIR A, SELECT, DIR B, TITLE, PRG-, MENU, TIME/LEVEL, and SET MENU. The YAMAHA logo is at the very bottom.

# FEATURES

- **5-Channel Power Amplification**  
**Minimum RMS Output Power**  
**<0.04% THD, 20 Hz – 20 kHz>**  
     **Main: 60 W + 60 W (8 Ω)**  
     **Center: 60 W (8 Ω)**  
     **Rear: 60 W + 60 W (8 Ω)**  
**<0.07% THD, 1 kHz>**  
     **Main: 70 W + 70 W (8 Ω)**  
     **Center: 70 W (8 Ω)**  
     **Rear: 70 W + 70 W (8 Ω)**
- **Digital Sound Field Processor**
- **Dolby Digital Decoder**
- **Dolby Pro Logic Surround Decoder**
- **CINEMA DSP: Theater-like Sound Experience by the Combination of Dolby Surround and YAMAHA DSP Technology**
- **6-Channel External Decoder Input for DTS and other future formats**
- **Automatic Input Balance Control for Dolby Pro Logic Surround**
- **Test Tone Generator for Easier Speaker Balance Adjustment**
- **Speaker Output Mode Changing Capability**
- **40-Station Random Access Preset Tuning**
- **Automatic Preset Tuning**
- **Preset Station Shifting Capability (Preset Editing)**
- **Video Signal Input/Output Capability**
- **SLEEP Timer**
- **Universal Remote Control Transmitter with Preset Manufacturer Codes**

# CONTENTS

SUPPLIED ACCESSORIES .....	4	● <b>Information about DSP</b>	
FEATURES .....	5	USING THE DIGITAL SOUND FIELD	
CAUTION .....	6	PROCESSOR (DSP) .....	38
● <b>Introduction</b>		● <b>Advanced Information</b>	
FEATURES OF SOUND EFFECTS .....	7	ADJUSTMENTS	
CONTROLS AND THEIR FUNCTIONS .....	9	IN THE "SET MENU" MODE .....	44
● <b>Preparation</b>		● <b>Remote Control Transmitter</b>	
SPEAKER SETUP .....	14	REMOTE CONTROL TRANSMITTER .....	46
CONNECTIONS .....	16	SETUP CODES .....	53
ADJUSTMENTS		TROUBLESHOOTING .....	54
BEFORE USING THIS UNIT .....	23	SPECIFICATIONS .....	57
● <b>Basic Operation</b>		LIST OF MANUFACTURER'S CODES .....	113
BASIC OPERATIONS .....	28		
TUNING OPERATIONS .....	32		
SETTING THE SLEEP TIMER .....	37		

# CAUTION: READ THIS BEFORE OPERATING YOUR UNIT.

1. To assure the finest performance, please read this manual carefully. Keep it in a safe place for future reference.
2. Install this unit in a cool, dry, clean place – away from windows, heat sources, sources of excessive vibration, dust, moisture and cold. Avoid sources of humming (transformers, motors). To prevent fire or electrical shock, do not expose the unit to rain or water.
3. Never open the cabinet. If something drops into the set, contact your dealer.
4. Do not use force on switches, controls or connection wires. When moving the unit, first disconnect the power plug and the wires connected to other equipment. Never pull the wires themselves.
5. The openings on the unit cover assure proper ventilation of the unit. If these openings are obstructed, the temperature inside the unit will rise rapidly. Therefore, avoid placing objects against these openings, and install the unit in a well-ventilated area to prevent fire and damage.  
**<Singapore model only>**  
Be sure to allow a space of at least 20 cm behind, 20 cm on the both sides and 30 cm above the top panel of the unit to prevent fire and damage.
6. The voltage used must be the same as that specified on this unit. Using this unit with a higher voltage than specified is dangerous and may result in fire or other accidents. YAMAHA will not be held responsible for any damage resulting from use of this unit with a voltage other than specified.
7. Digital signals generated by this unit may interfere with other equipment such as tuners, receivers or TVs. Move this unit farther away from such equipment if interference is observed.
8. Always set the VOLUME control to “∞” before starting the audio source play. Increase the volume gradually to an appropriate level after playback has been started.
9. Do not attempt to clean the unit with chemical solvents; this might damage the finish. Use a clean, dry cloth.
10. Be sure to read the “TROUBLESHOOTING” section regarding common operating errors before concluding that the unit is faulty.
11. When not planning to use this unit for long periods of time (ie., vacation, etc.), disconnect the AC power plug from the wall outlet.
12. To prevent lightning damage, disconnect the AC power plug and disconnect the antenna cable when there is an electrical storm.
13. Grounding or polarization – Precautions should be taken so that the grounding or polarization of an appliance is not defeated.
14. AC outlet  
Do not connect audio equipment to the AC outlet on the rear panel if that equipment requires more power than the outlet is rated to provide.
15. **Voltage Selector (China and General Models only)**  
**The voltage selector on the rear panel of this unit must be set for your local main voltage BEFORE plugging into the AC main supply.**  
**Voltages are 110/120/220/240 V AC, 50/60 Hz.**

This unit is not disconnected from the AC power source as long as it is connected to the wall outlet, even if this unit itself is turned off. This state is called the standby mode. In this state, this unit is designed to consume a very small quantity of power.

## **FREQUENCY STEP switch (China and General Models only)**

Because the interstation frequency spacing differs in different areas, set the FREQUENCY STEP switch (located at the rear) according to the frequency spacing in your area. Before setting this switch, disconnect the AC power plug of this unit from the AC outlet.

## **IMPORTANT**

Please record the serial number of this unit in the space below.

MODEL:

Serial No.:

The serial number is located on the rear of the unit. Retain this Owner's Manual in a safe place for future reference.

## **WARNING**

**TO REDUCE THE RISK OF FIRE OR ELECTRIC SHOCK,  
DO NOT EXPOSE THIS UNIT TO RAIN OR MOISTURE.**

## **FOR CANADIAN CUSTOMERS**

To prevent electric shock, match wide blade of plug to wide slot and fully insert.

This Class B digital apparatus complies with Canadian ICES-003.

# FEATURES OF SOUND EFFECTS

## Introduction

---

Welcome to the exciting world of digital home entertainment. This unit is one of the most complete and advanced AV receivers available. Some of the more advanced features may not be familiar to you, but they are easy to use. State-of-the-art technologies such as Dolby Digital and Digital Theater Systems (DTS) may be new to your home, but you have probably experienced the amazing realism they bring to feature films in theaters around the world.

To make the listening experience even more enjoyable, this unit includes a number of exclusive, digitally created listening environments known as digital sound fields. Choosing a sound field program is like transporting yourself to such venues as an outdoor arena, a European church, or a cozy jazz club. Take some time now to read more about these features and enjoy the new experiences this unit brings to your home theater.

## Digital Sound Field Processing

---

What is it that makes live music so good? Today's advanced sound reproduction technology lets you get extremely close to the sound of a live performance, but the chances are that you'll still notice something missing — the acoustic environment of the live concert hall. Extensive research into the exact nature of the sonic reflections that create the ambience of a large hall has made it possible for YAMAHA engineers to bring you this same sound to your listening room, so you'll feel all the sound of a live concert.

Furthermore, our technicians, armed with sophisticated measuring equipment, have even made it possible to capture the acoustics of a variety of actual concert halls, theaters, etc. from around the world, to allow you to accurately re-create any one of these live performance environments, all in your own home.

## Dolby Pro Logic Surround

---

Dolby Pro Logic Surround has been used in movie theaters since the mid-seventies. It has also been available in home entertainment systems since the late eighties and continues to be a popular format for home theater systems. It uses four discrete channels and five speakers to reproduce realistic and dynamic sound effects: two main channels (left and right), a center channel for dialog, and a rear channel for special sound effects. The rear channel reproduces sound within a narrow frequency range.

Most video tapes and laser discs include Dolby Pro Logic Surround encoding, as do many TV and cable broadcasts. The Dolby Pro Logic Surround decoder built into this unit employs a digital signal processing system that stabilizes each channel for even more accurate sound positioning than is available with standard analog processors.

## Dolby Digital

---

The built-in Dolby Digital decoder leads you into a totally new sound experience.

Dolby Digital is a new generation of multi-channel digital audio technology, or the newest spatial sound processing format developed for 35 mm-film movies by employing a new kind of low bit-rate audio coding.

Dolby Digital is a digital surround sound system that provides completely independent multi-channel audio to listeners. In multi-channel form, Dolby Digital provides 5 full-range channels in what is sometimes referred to as a "3/2" configuration: three front channels (left, center and right), plus two surround channels. A sixth bass-only effect channel is also provided for output of LFE (low frequency effect), or low bass effects that are independent of other channels. This channel is counted as 0.1, thus giving rise to the term 5.1 channels in total.

Compared to Dolby Pro Logic, which is referred to a "3/1" system (left front, center, right front and just one surround channel), Dolby Digital features two surround channels, called stereo or split surrounds, each offering the same full-range fidelity as the three front channels.

Sound of wide dynamic range reproduced by the 5 full-range channels provides listeners with excitement that has never been experienced before. Precise sound orientation by discrete digital sound processing expands the realism that the original movie possesses.

LD and DVD are home audio/video program source that could benefit from Dolby Digital. In the near future, Dolby Digital will also be applied to DBS, CATV and HDTV. The ongoing release of Dolby Stereo Digital theatrical films now underway will provide an immediate source of Dolby Digital encoded video software.



Manufactured under license from Dolby Laboratories Licensing Corporation. "DOLBY", "PRO LOGIC", and the double-D symbol are trademarks of Dolby Laboratories Licensing Corporation. Copyright 1992 Dolby Laboratories, Inc. All rights reserved.

## CINEMA DSP: Dolby Surround + DSP

The Dolby Surround sound system shows its full ability in a large movie theater, because movie sounds are originally designed to be reproduced in a large movie theater using many speakers. It is difficult to create a sound environment similar to that of a movie theater in your listening room, because the room size, materials of inside walls, the number of speakers, etc. of your listening room are very different from those of a movie theater.

The following original functions make the surround-sound effect of Dolby Digital become the most suitable for your audio system and the listening conditions.

YAMAHA DSP technology made it possible to present you with nearly the same sound experience as that of a large movie theater in your listening room by compensating for the lack of presence and dynamics in your listening room with its original digital sound fields combined with the Dolby Surround sound system.

### CINEMA DSP

The YAMAHA "CINEMA DSP" logo indicates those programs that are created by the combination of Dolby Surround and YAMAHA DSP technology.

#### Dolby Pro Logic + 2 Digital Sound Fields

Digital sound fields are created on the presence side and the rear surround side of the Dolby Pro Logic Surround-decoded sound field, respectively. They create a wide acoustic environment and emphasize the surround effect in the room, letting you feel as much presence as if you are watching a movie in a popular Dolby Stereo theater.

This combination is available when the **DOLBY PRO LOGIC ENHANCED/DOLBY DIGITAL ENHANCED, 70 mm MOVIE THEATER/DIGITAL MOVIE THEATER** or **TV SPORTS** sound field program is selected, and the input signal of source is analog, PCM audio or encoded with Dolby Digital sound in 2-channel.

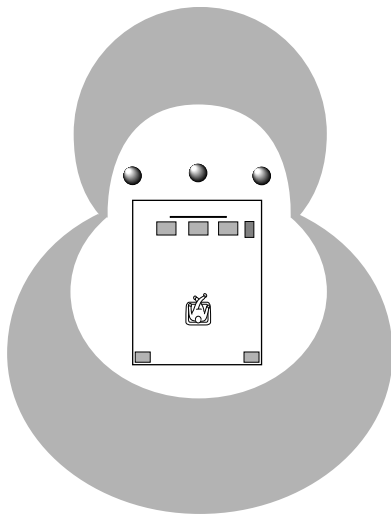

#### Dolby Digital + 3 Digital Sound Fields

Digital sound fields are created on the presence side and the independent left and right surround sides of the Dolby Digital-decoded sound field, respectively. They create a wide acoustic environment and strong surround effect in the room without losing high-channel separation. With the wide dynamic range of Dolby Digital sound, this sound field combination lets you feel as if you are watching a movie in the newest Dolby Stereo Digital theater. This will be the most ideal home theater sound at the present time.

This combination is available when the **DOLBY PRO LOGIC ENHANCED/DOLBY DIGITAL ENHANCED, 70 mm MOVIE THEATER/DIGITAL MOVIE THEATER** or **TV SPORTS** sound field program is selected, and the input signal of source is encoded with Dolby Digital sound (except in 2-channel).

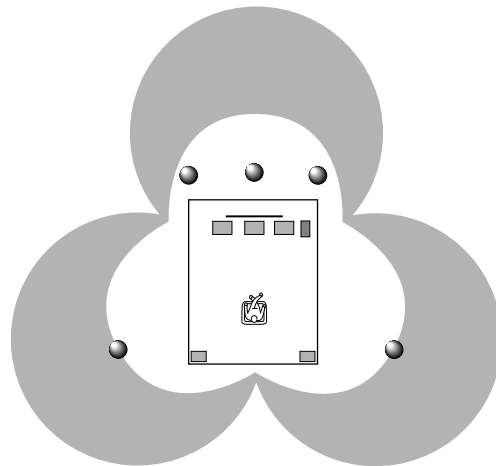



# CONTROLS AND THEIR FUNCTIONS

## FRONT PANEL

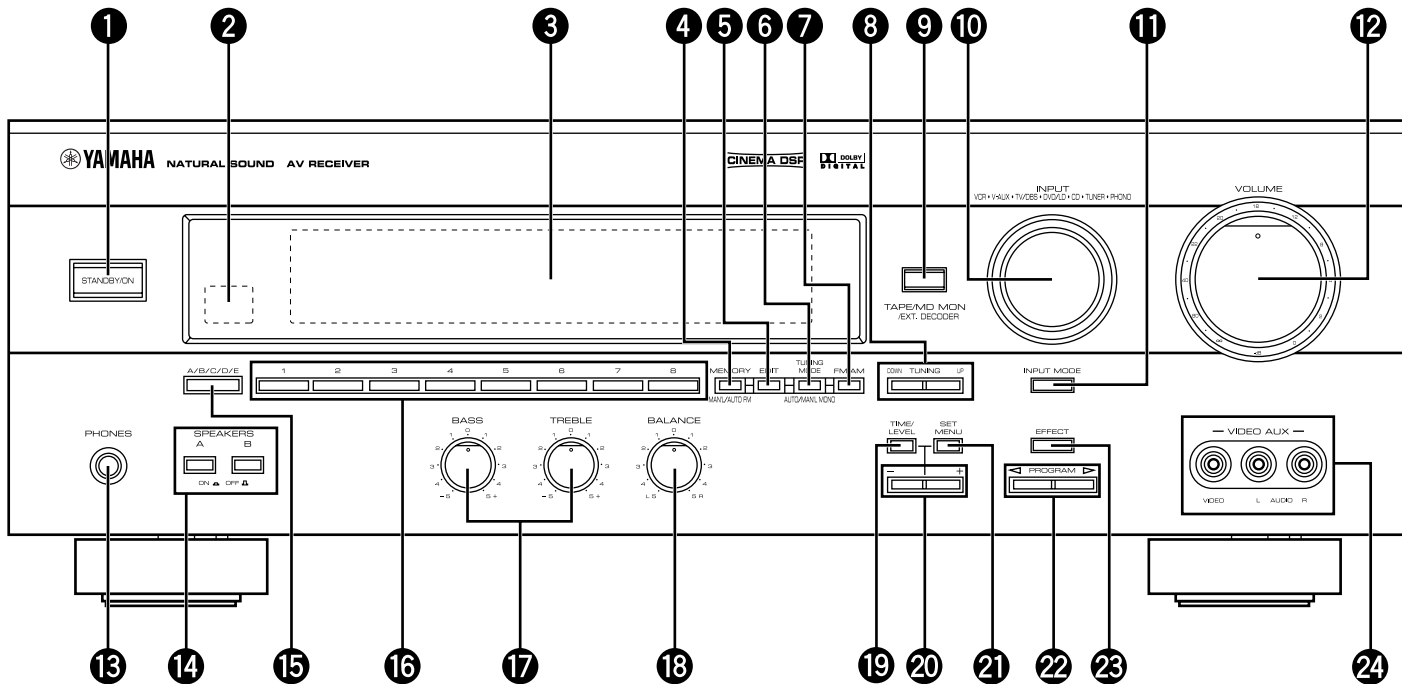

### 1 STANDBY/ON

Press this switch to turn on the power to this unit. Press it again to set this unit to the standby mode.

#### Standby mode

In this state, this unit consumes a very small quantity of power to receive infrared-signals from the remote control transmitter.

### 2 Remote control sensor

This receives signals from the remote control transmitter.

### 3 Display

This shows various information. (Refer to page 11 for details.)

### 4 MEMORY (MAN'L/AUTO FM)

Press this button to store the broadcasting stations. When this button is pressed and held for more than three seconds, the automatic preset tuning begins.

### 5 EDIT

This button is used to exchange the assignment of two preset stations with each other.

### 6 TUNING MODE (AUTO/MAN'L MONO)

Press this button to switch the tuning mode to automatic or manual. To select the automatic tuning mode, press this button so that the "AUTO TUNING" indicator lights up on the display. To select the manual tuning mode, press this button so that the "AUTO TUNING" indicator goes off.

### 7 FM/AM

Press this button to switch the reception band to FM or AM.

### 8 TUNING UP/DOWN

This button is used for tuning. Press the UP side to tune in to higher frequencies, and press the DOWN side to tune in to lower frequencies.

### 9 TAPE/MD MON / EXT. DECODER

Press this button to play a tape or an MD. The "TAPE/MD MON" indicator lights up on the display. When you press the button next, the "TAPE/MD MON" indicator goes off, "EXT. DECDR" appears on the display and you can play the signal connected to the **EXTERNAL DECODER INPUT** terminals.

### 10 INPUT

Turn this selector to select the program source (VCR, VIDEO AUX, TV/DBS, DVD/LD, CD, TUNER, PHONO) to listen to or watch.

The name of the selected program source appears on the display.

### 11 INPUT MODE

This button switches the DVD/LD and TV/DBS input signal mode (AUTO/ANALOG).

### 12 VOLUME

This control is used to raise or lower the volume level.

### 13 PHONES jack

When you use headphones, connect the headphones to the **PHONES** jack. You can listen to the sound to be output from the main speakers through the headphones.

When using headphones only, set both **SPEAKERS A** and **B** to the OFF position and switch off the digital sound field processor (so that no DSP program name appears on the display) by pressing **EFFECT**.

### 14 SPEAKERS

Set **A** or **B** (or both **A** and **B**) to the ON position for the main speaker system (connected to this unit) that you want to use. Set the button(s) for the main speaker system you don't want to use to the OFF position.

### 15 A/B/C/D/E

Press this button to select one of a group (A to E) of preset stations.

### 16 Preset station number selector

Each of these buttons selects a preset station number (1 to 8).

### 17 Tone controls

These controls are only effective for the sound from the main speakers.

#### BASS

Use this control to increase or decrease the low-frequency response. The "0" position produces flat response.

#### TREBLE

Use this control to increase or decrease the high-frequency response. The "0" position produces flat response.

### 18 BALANCE

This control is only effective for the sound from the main speakers.

Turn the control to adjust the balance of the output volume to the left and right speakers to compensate for sound imbalance caused by the speaker location or listening room conditions.

### 19 TIME/LEVEL

Press this button to select the item in the TIME/LEVEL mode.

### 20 +/-

These buttons are used to adjust the settings of the SET MENU mode and the TIME/LEVEL mode. In the TIME/LEVEL mode, press **+** to increase the delay time or speaker output level. Press **-** to decrease the delay time or speaker output level.

### 21 SET MENU

Press this button to select functions in the SET MENU mode.

### 22 PROGRAM selector

Press **<** or **>** to select the DSP program.

The name of the selected program appears on the display.

### 23 EFFECT

This button switches on and off the output from the center and rear speakers so that the sound becomes the normal 2-channel.

\* Even if the output from the center and rear speakers is off, when the Dolby Digital is decoded, the signals on all channels are distributed to the main channels and output from the main speakers.

### 24 VIDEO AUX terminals

Connect an auxiliary video or audio input source unit such as a camcorder to these terminals. The source connected to these terminals can be selected by **INPUT**.

## DISPLAY PANEL

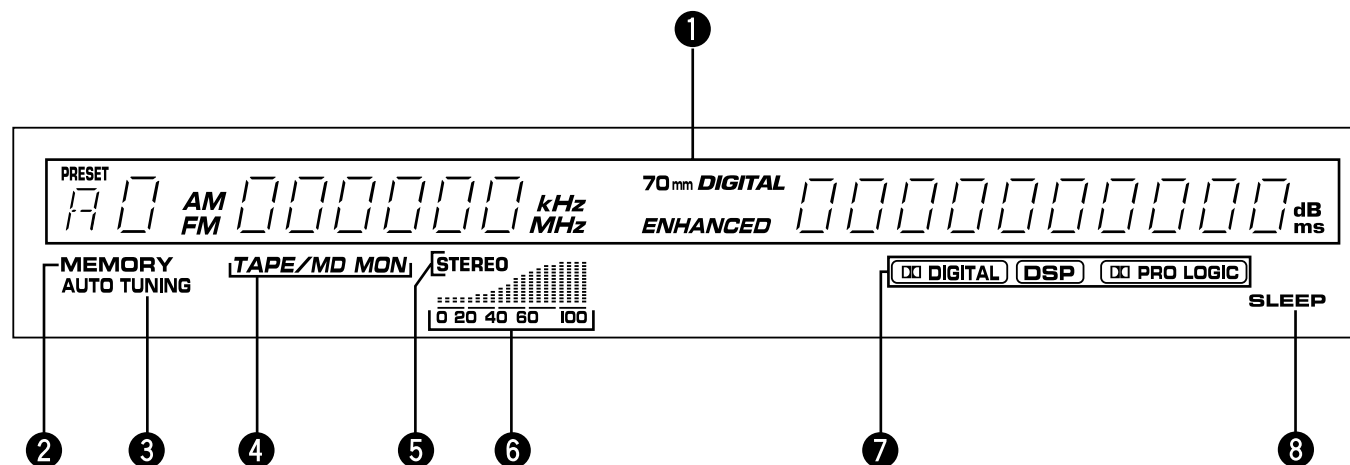

### 1 Multi-information display

This displays various information, for example the station frequency, preset station number and name of the selected program source.

### 2 MEMORY indicator

When **MEMORY** is pressed, this indicator flashes for about five seconds. During this period, the displayed station can be stored in the memory.

### 3 AUTO TUNING indicator

This lights up when the unit is in the automatic tuning mode.

### 4 TAPE/MD MON indicator

This lights up when the tape deck (or MD recorder, etc.) is selected as the program source by pressing **TAPE/MD MON / EXT. DECODER** on the front panel or **TAPE/MD** on the remote control transmitter.

### 5 STEREO indicator

This lights up when an FM stereo broadcast with sufficient signal strength is being received.

### 6 Signal-level meter

This indicates the signal level of the station being received. If multipath interference is detected, the indication decreases.

### 7 DIGITAL, DSP and PRO LOGIC indicators

“**DIGITAL**” lights up when the built-in Dolby Digital decoder is on and the signal of the selected source encoded in Dolby Digital sound is not in 2-channel. “**DSP**” lights up when the built-in digital sound field processor is on, and “**PRO LOGIC**” lights up when the built-in Dolby Pro Logic Surround decoder is on. Depending on the selected DSP program, both “**DIGITAL**” and “**DSP**”, or both “**DSP**” and “**PRO LOGIC**” will light up.

### 8 SLEEP indicator

This lights up while the built-in SLEEP timer is functioning.

# REMOTE CONTROL TRANSMITTER

See "REMOTE CONTROL TRANSMITTER" on page 46 for full details.

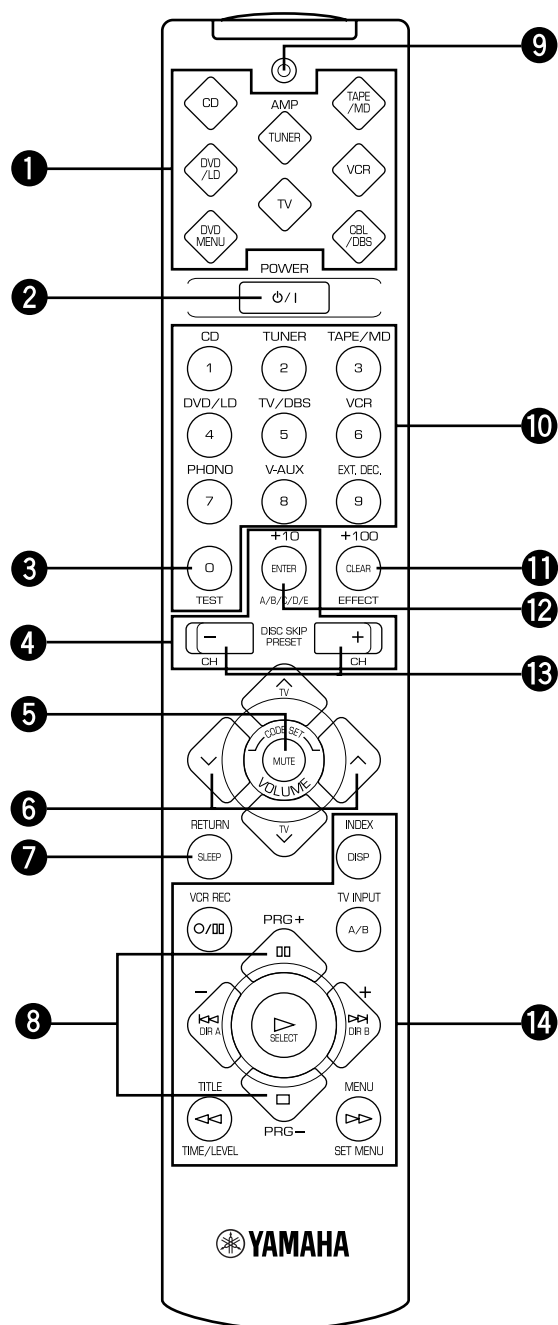

## 1 Component selector

Press the button for the component you want to control with the remote control transmitter. (The proper code must be set for your component. See "SETUP CODES" on page 53.)

When the component selector has been pressed, the remote control transmitter is set to operate that component.

## 2 POWER

When you have preset the code for a YAMAHA component, this button switches between the power on and standby mode.

When you have preset the code for another manufacturer's component, this button turns on that component if it has a remote control transmitter with a power button.

\* It only functions when **AMP<TUNER>**, **TAPE/MD**, **CD**, **DVD/LD** or **DVD MENU** on the component selector has been pressed.

## 3 TEST

Press this button to output the test tone for each speaker.

\* It only functions when **AMP<TUNER>** on the component selector has been pressed.

## 4 A/B/C/D/E, PRESET +/-

These buttons are used to select a preset station.

\* They only function when **AMP<TUNER>** on the component selector has been pressed.

## 5 MUTE

Press this button to mute the sound.

## 6 VOLUME

These buttons are used to adjust the volume.

∧: Turns up the volume.

∨: Turns down the volume.

## 7 SLEEP

This button is used to set the SLEEP timer.

## 8 PRG+, PRG-

These buttons are used to select a DSP program.

\* They only function when **AMP<TUNER>** on the component selector has been pressed.

## 9 Indicator

This flashes in red when a button on the remote control transmitter is pressed. When it flashes rapidly several times, press the selected button again.

## 10 Input selector (1 to 9)<sup>1)</sup>/Numeric buttons<sup>2)</sup>

1) These buttons are used to select the program source to be played.

\* They only function when **AMP<TUNER>**, **TAPE/MD**, **CD** or **DVD/LD** on the component selector has been pressed.

2) These buttons are used to select the menu or channel.

\* They only function when **DVD MENU**, **VCR**, **CBL/DBS** or **TV** on the component selector has been pressed.

**11 EFFECT<sup>1)</sup>/CLEAR<sup>2)</sup>/+100<sup>3)</sup>**

- 1) This button is used to switch the DSP program on or off.
  - \* It only functions when **AMP<TUNER>**, **TAPE/MD**, **CD**, **DVD/LD**, **VCR** or **TV** on the component selector has been pressed.
- 2) This button is used to clear the settings.
  - \* It only functions when **DVD MENU** on the component selector has been pressed.
- 3) This button is used to select the channel.
  - \* It only functions when **CBL/DBS** on the component selector has been pressed.

**12 ENTER<sup>1)</sup>/+10<sup>2)</sup>**

- 1) This button is used to enter the channel.
  - \* It only functions when **VCR**, **CBL/DBS** or **TV** on the component selector has been pressed.
- 2) This button is used to select the menu.
  - \* It only functions when **DVD MENU** on the component selector has been pressed.

**13 DISC SKIP +/-<sup>1)</sup>/CH +/-<sup>2)</sup>**

- 1) These buttons are used to skip to the next or previous disc.
  - \* They only function when **CD**, **DVD/LD** or **DVD MENU** on the component selector has been pressed.
- 2) These buttons are used to select the next or previous channel.
  - \* They only function when **VCR**, **CBL/DBS** or **TV** on the component selector has been pressed.

**14 Operation buttons<sup>1)</sup>/Setup buttons<sup>2)</sup>**

- 1) These buttons function as play, stop, skip, etc. for operating the component.
  - \* They only function when **TAPE/MD**, **CD**, **DVD/LD**, **VCR** or **TV** on the component selector has been pressed.
- 2) These buttons are for adjusting various settings.
  - \* They only function when **AMP<TUNER>**, **DVD MENU** or **CBL/DBS** on the component selector has been pressed.

# SPEAKER SETUP

## SPEAKERS TO BE USED

This unit is designed to provide the best sound-field quality with a 5-speaker configuration, using main speakers, rear speakers and a center speaker.

The main speakers are used for the main source sound plus the effect sounds. They will probably be the speakers from your present stereo system. The rear speakers are used for the effect and surround sounds, and the center speaker is for the center sounds (dialog, vocals, etc.). If for some reason it is not practical to use a center speaker, you can do without it. Best results, however, are obtained with the full system.

The main speakers should be high-performance models and have enough power-handling capacity to accept the maximum output of your audio system.

The other speakers do not have to be equal to the main speakers. For precise sound localization, however, it is ideal to use high-performance models that can reproduce sounds over the full-range for the center speaker and the rear speakers.

### Use of a subwoofer expands your sound field

It is also possible to further expand your system with the addition of a subwoofer and amplifier. The use of a subwoofer is effective not only for reinforcing bass frequencies from any or all channels, but also for reproducing the LFE (low frequency effect) sound with high fidelity when playing back a source that is Dolby Digital-decoded. You may wish to choose the convenience of a YAMAHA Active Servo Processing Subwoofer System, which has its own built-in power amplifier.

## SPEAKER CONFIGURATION

### 5-Speaker Configuration

This configuration is the most effective and recommended one. When playing back a source using the DSP program, **DOLBY PRO LOGIC/DOLBY DIGITAL, DOLBY PRO LOGIC ENHANCED/DOLBY DIGITAL ENHANCED, 70 mm MOVIE THEATER/DIGITAL MOVIE THEATER, MONO MOVIE** or **TV SPORTS**, or when playing back a source which contains center-channel signals (dialog, vocals, etc.) using any DSP program that is Dolby Digital-decoded, conversations will be output from the center speaker and the ambience will be excellent.

**Note:** Set the CNTR (CENTER SPEAKER) mode to the "LARGE" or "SMALL" position. (See page 23 for details.)

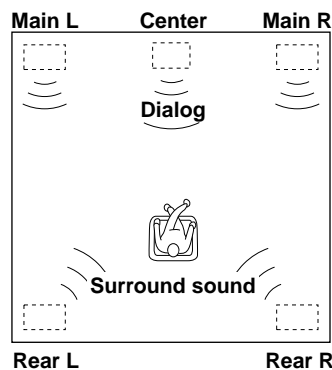

### 4-Speaker Configuration

The center speaker is not used in this configuration. When playing back a source using the DSP program, **DOLBY PRO LOGIC/DOLBY DIGITAL, DOLBY PRO LOGIC ENHANCED/DOLBY DIGITAL ENHANCED, 70 mm MOVIE THEATER/DIGITAL MOVIE THEATER, MONO MOVIE** or **TV SPORTS**, or when playing back a source which contains center-channel signals (dialog, vocals, etc.) using any DSP program that is Dolby Digital-decoded, the center sound is output from the left and the right main speakers. However, the sound effect of other programs will be the same as that of the 5-speaker configuration.

**Note:** Be sure to set the CNTR (CENTER SPEAKER) mode to the "NONE" position. (See page 23 for details.)

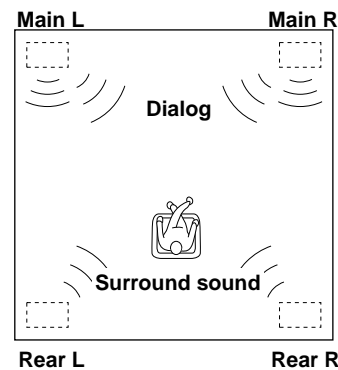

## SPEAKER PLACEMENT

Refer to the following diagram when you place the speakers.

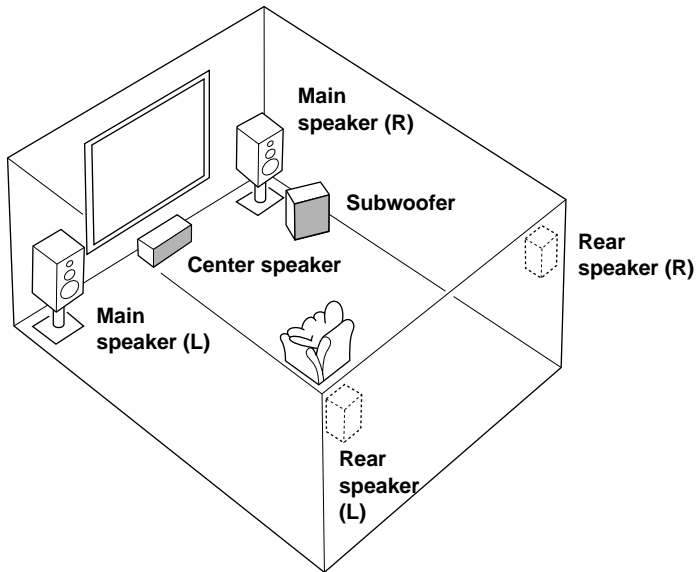

- Main:** The position of your present stereo speaker system.
- Rear:** Behind your listening position, facing slightly inward. Nearly 1.8 m (approx. 6 feet) up from the floor.
- Center:** Precisely between the main speakers. (To avoid interference with TV sets, use a magnetically shielded speaker.)
- Subwoofer:** The position of the subwoofer is not as critical, because low bass tones are not highly directional.

# CONNECTIONS

Never plug in this unit and other components until all connections have been completed.

## CONNECTIONS WITH OTHER COMPONENTS

When making connections between this unit and other components, be sure all connections are made correctly, that is to say L (left) to L, R (right) to R, “+” to “+” and “-” to “-”. Also, refer to the owner’s manual for each component to be connected to this unit.

\* If you have YAMAHA components numbered as 1, 3, 4, etc. on the rear panel, connections can be made easily by making sure to connect the output (or input) terminals of each component to the same-numbered terminals of this unit.

### \*<sup>1</sup> SWITCHED AC OUTLET(S)

U.S.A., Canada, Singapore, China and General models ..... 2 SWITCHED OUTLETS  
 Australia model ..... 1 SWITCHED OUTLET

Use these to connect the power cords from your components to this unit.

The power to the **SWITCHED AC OUTLET(S)** is controlled by this unit’s **STANDBY/ON** or the provided remote control transmitter’s **POWER**. These outlets will supply power to any component whenever this unit is turned on.

The maximum power (total power consumption of components) that can be connected to the **SWITCHED AC OUTLET(S)** is 100 watts.

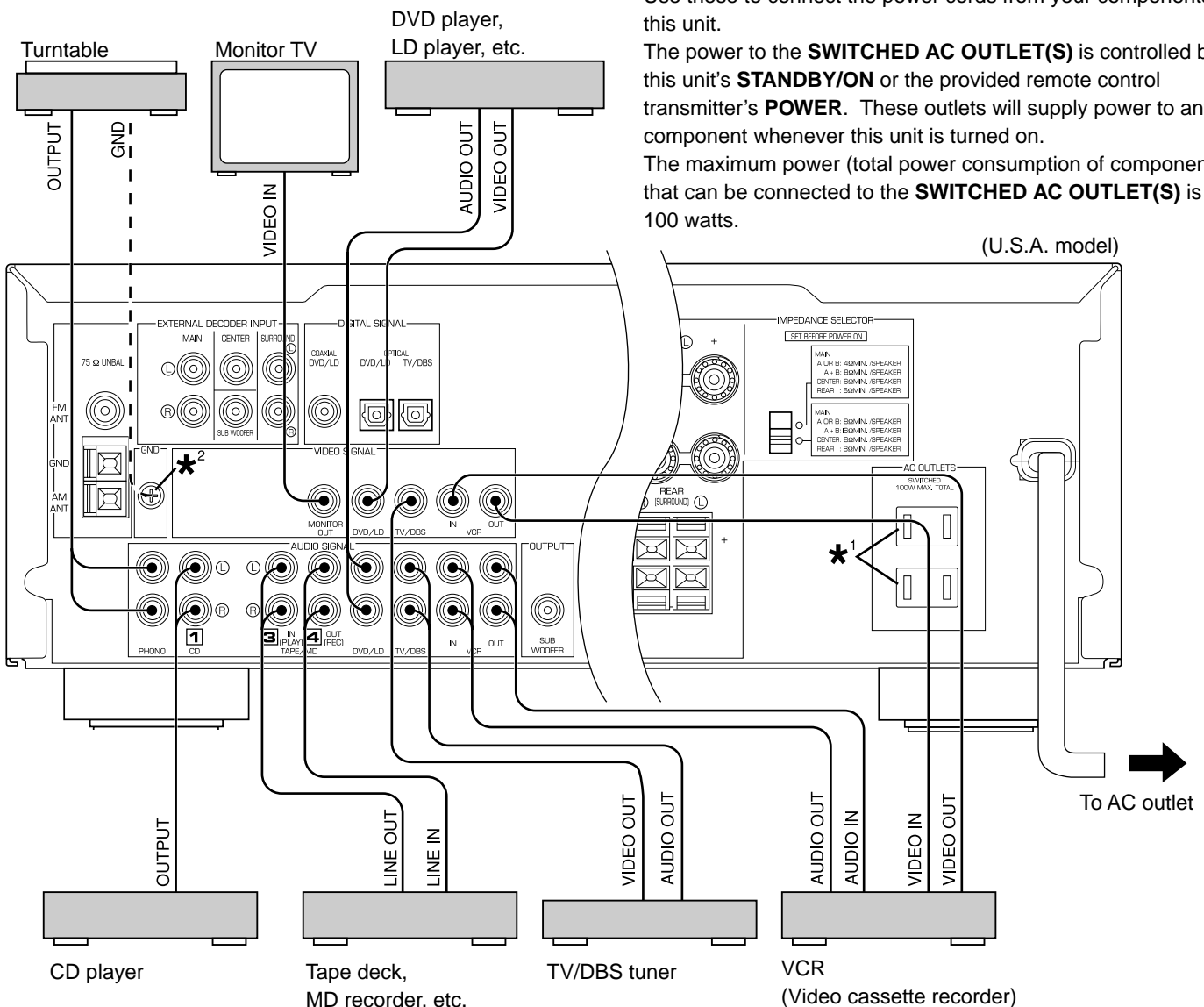

### \*<sup>2</sup> GND terminal (for turntable use)

Connecting the ground (earth) wire of the turntable to the **GND** terminal will normally minimize hum, but in some cases, better results may be obtained with the ground wire disconnected.



## CONNECTING TO VIDEO AUX TERMINALS (ON THE FRONT PANEL)

These terminals are used to connect any video input source, such as a camcorder, to this unit.

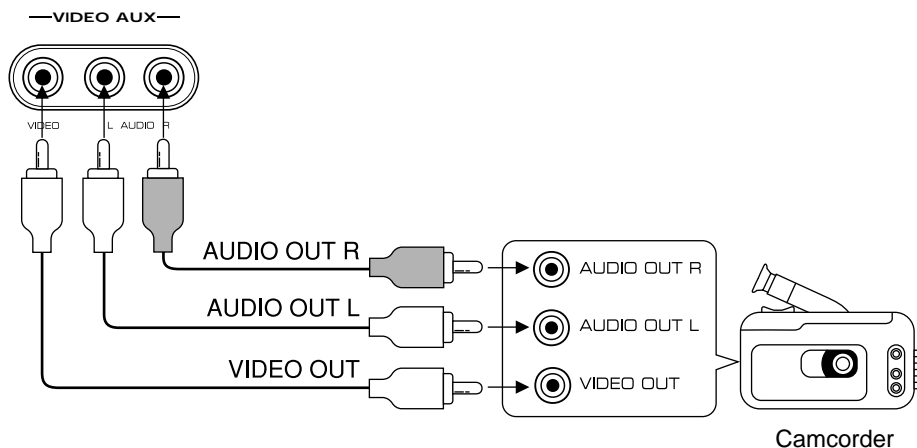

## CONNECTING TO AN EXTERNAL DECODER

When using the DTS or other decoder with 6-channel discrete outputs, connect the **6CH DISCRETE OUTPUT** terminals of the decoder to the **EXTERNAL DECODER INPUT** terminals of this unit.

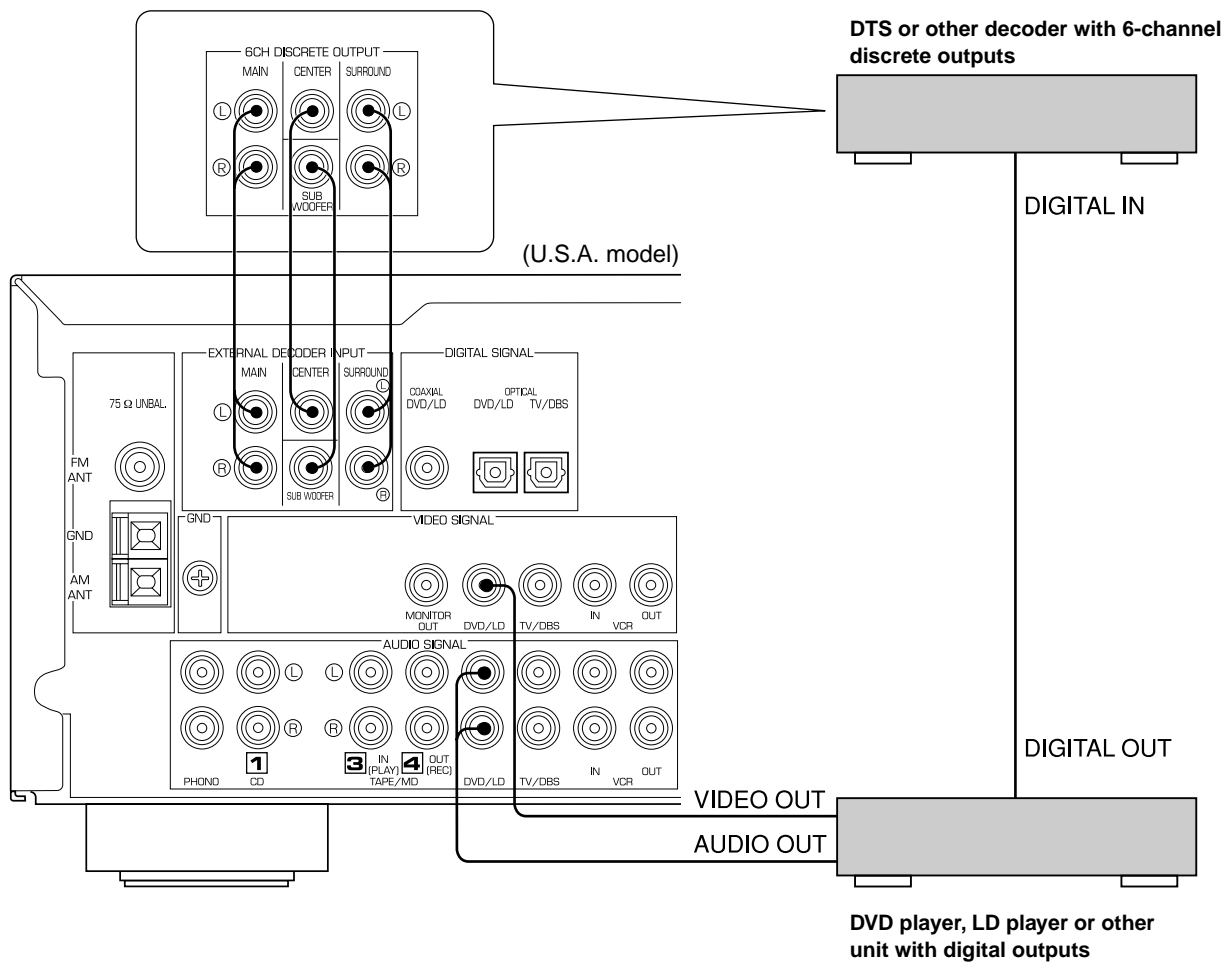

## CONNECTING TO DIGITAL (COAXIAL AND/OR OPTICAL) TERMINALS

If your DVD (LD) player, TV/DBS tuner, etc. are equipped with coaxial or optical digital audio signal output terminals, they can be connected to this unit's **COAXIAL** and/or **OPTICAL** digital signal input terminals.

To make a connection between optical digital audio signal terminals, remove the cover from each terminal, and then connect them by using a commercially available optical fiber cable that conforms to EIAJ standards. Other cables might not function correctly.

Even if you connect an audio/video unit to the **COAXIAL** (or **OPTICAL**) terminal of this unit, you must keep the unit connected with the same named analog audio signal terminals of this unit, because a digital signal cannot be recorded by a tape deck, MD recorder or VCR connected to this unit. You can easily switch the selection of input signals between "digital" and "analog". (See page 30 for details.)

### Notes

- When connecting an audio/video unit to both the digital and analog terminals of this unit, make sure to connect between terminals of the same name.
- Be sure to attach the covers when the **OPTICAL** terminals are not being used in order to protect them from dust.
- The input signal from the DVD/LD input terminals is selected in the following order of priority with the input mode set to the AUTO position:
  - 1 **COAXIAL** terminal
  - 2 **OPTICAL** terminal
  - 3 Analog terminal
- All digital audio signal input terminals are applicable to sampling frequencies of 32 kHz, 44.1 kHz and 48 kHz.
- If your LD player has Dolby Digital RF signal output terminal and not digital signal output, use the RF demodulator (separate purchase).

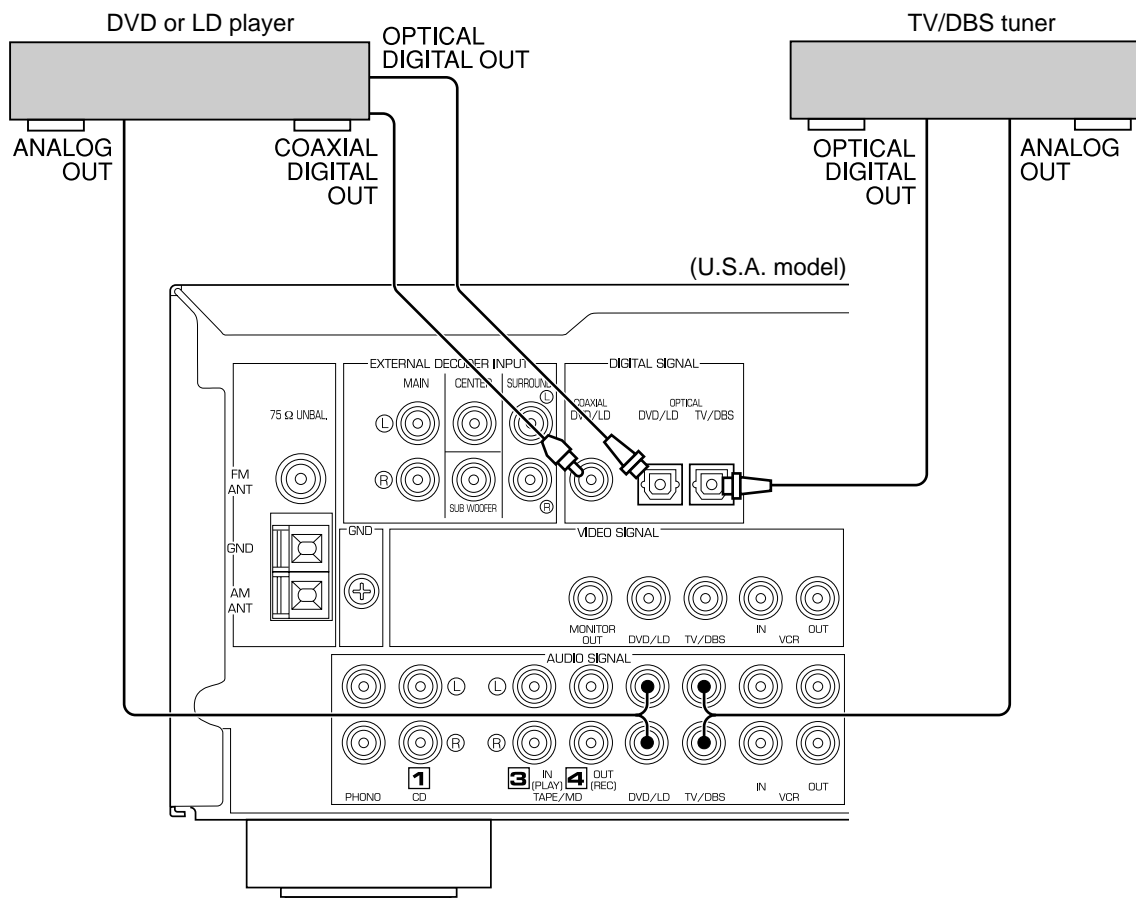

## CONNECTING SPEAKERS

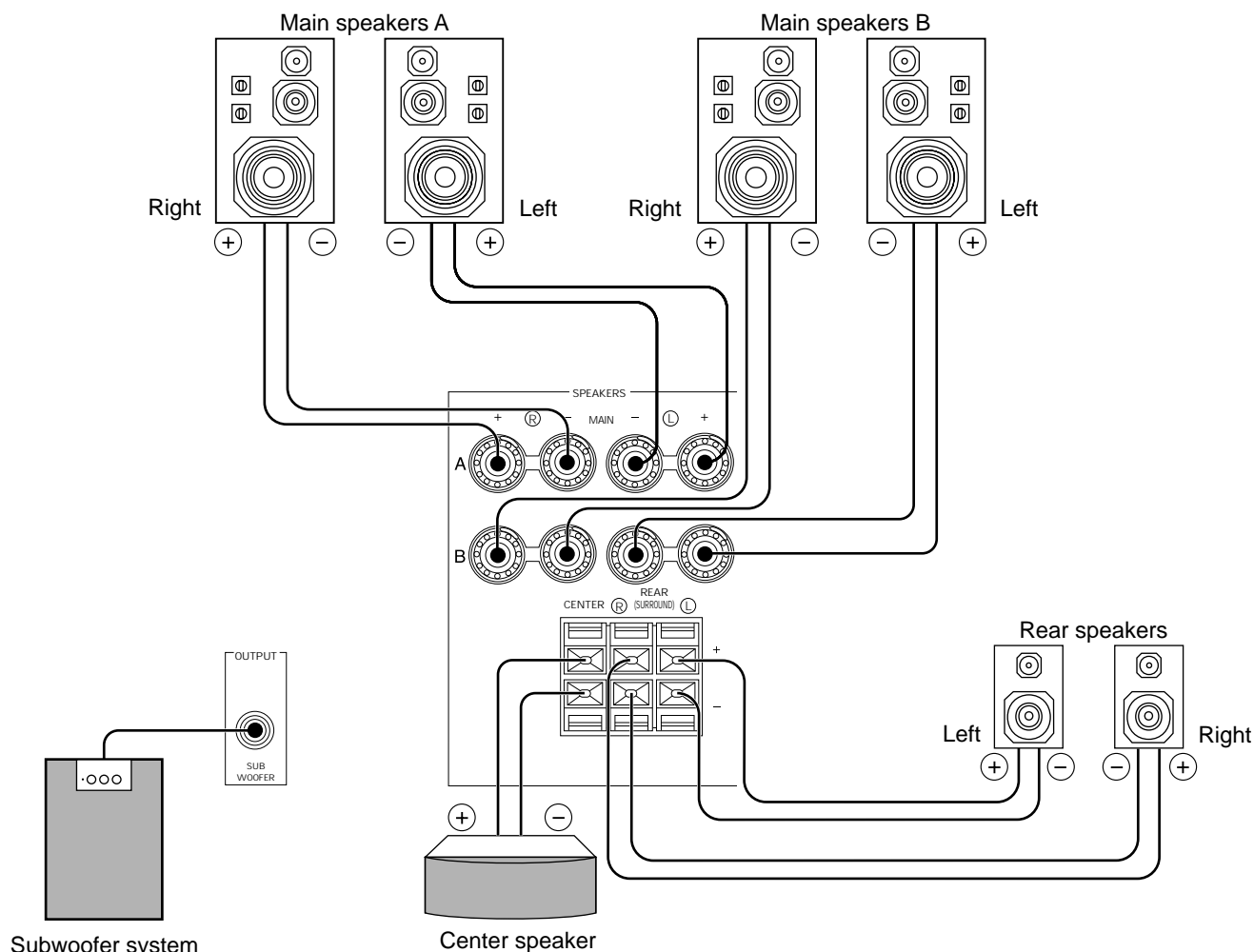

### Note

Use speakers with the specified impedance shown on the rear panel of this unit.

### Main speaker connections

One or two speaker systems can be connected to this unit. If you use only one speaker system, connect it to either of the **SPEAKERS A** or **B** terminals.

### Rear speaker connections

A rear speaker system can be connected to this unit. Place them to the rear of your listening position.

### Center speaker connection

A center speaker can be connected to this unit. Place it on or under the TV.

### Subwoofer connection

You may wish to add a subwoofer to reinforce low frequencies or to output low bass sound from the subwoofer channel.

If you have a subwoofer with built-in amplifier, including the YAMAHA Active Servo Processing Subwoofer System, connect the **SUBWOOFER OUTPUT** terminal of this unit to the input terminal of the subwoofer system.

If you have a separate amplifier and subwoofer, connect the **SUBWOOFER OUTPUT** terminal of this unit to the input terminal of the subwoofer amplifier, and then connect the speaker terminals of the subwoofer amplifier to the subwoofer. When the input signals to this unit are for normal 2-channel stereo, this terminal outputs only frequencies below 90 Hz from the main and center channels. When discrete signals are input to this unit and are selected as the input source, this terminal outputs signals from the subwoofer channel.

**Note:** The output level of signals from this terminal is adjusted by **VOLUME** on the front panel or **VOLUME** ( ^ v ) on the remote control transmitter.

## How to connect

Connect the **SPEAKERS** terminals to your speakers with wire of the proper gauge, cut as short as possible. If the connections are faulty, no sound will be heard from the speakers. Make sure that the polarity of the speaker wires is correct, that is the + and – markings are observed. If these wires are reversed, the sound will be unnatural and lack bass.

### Caution

**Do not let the bare speaker wires touch each other and do not let them touch any metal part of this unit. This could damage the unit and/or speakers.**

### Connecting to the MAIN SPEAKERS terminals

Red: positive (+)  
Black: negative (–)

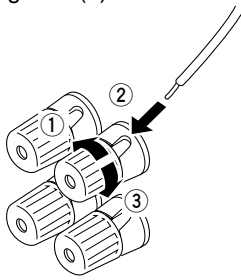

- ① Unscrew the knob.
- ② Remove approx. 5 mm (1/4") of insulation from each of the speaker wires and insert the bare wire into the terminal.
- ③ Tighten the knob to secure the wire.

### Connecting to the REAR and CENTER SPEAKERS terminals

Red: positive (+)  
Black: negative (–)

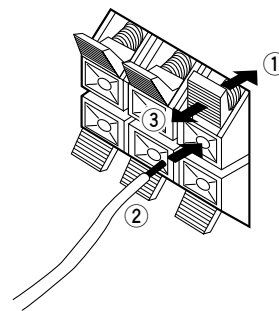

- ① Press the tab.
- ② Remove approx. 5 mm (1/4") of insulation from each of the speaker wires and insert the bare wire into the terminal.
- ③ Release the tab to secure the wire.

Banana plug connections are also possible (except for the Singapore model). Simply insert the banana plug connector into the corresponding terminal.

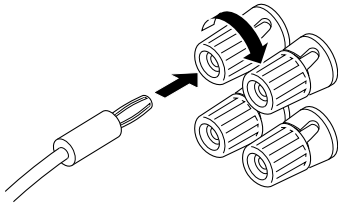

## IMPEDANCE SELECTOR SWITCH

### WARNING

Do not change the **IMPEDANCE SELECTOR** switch setting while the power to this unit is on, otherwise this unit may be damaged.

If this unit fails to turn on when the STANDBY/ON switch is pressed, the **IMPEDANCE SELECTOR** switch may not be fully set to either end. If so, set the switch to either end fully when this unit is in the standby mode.

### IMPEDANCE SELECTOR

(U.S.A. model)

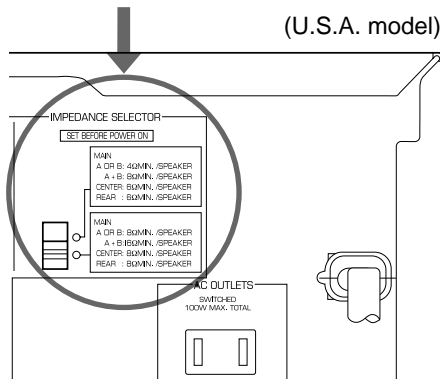

Select the position whose requirements your speaker system meets.

 (Upper position)

**Main:** If you use one pair of main speakers, the impedance of each speaker must be 4  $\Omega$  or higher.  
If you use two pairs of main speakers, the impedance of each speaker must be 8  $\Omega$  or higher.

**Center:** The impedance of the speaker must be 6  $\Omega$  or higher.

**Rear:** The impedance of each speaker must be 6  $\Omega$  or higher.

 (Lower position)

**Main:** If you use one pair of main speakers, the impedance of each speaker must be 8  $\Omega$  or higher.  
If you use two pairs of main speakers, the impedance of each speaker must be 16  $\Omega$  or higher.  
<Canada model only>  
The impedance of each speaker must be 8  $\Omega$  or higher.

**Center:** The impedance of the speaker must be 8  $\Omega$  or higher.

**Rear:** The impedance of each speaker must be 8  $\Omega$  or higher.

# ANTENNA CONNECTIONS

Each antenna should be correctly connected to the designated terminals, referring to the following diagram. Both AM and FM indoor antennas are included with this unit. In general, these antennas will probably provide sufficient signal strength. Nevertheless, a properly installed outdoor antenna will give clearer reception than an indoor one. If you experience poor reception quality, an outdoor antenna may result in improvement.

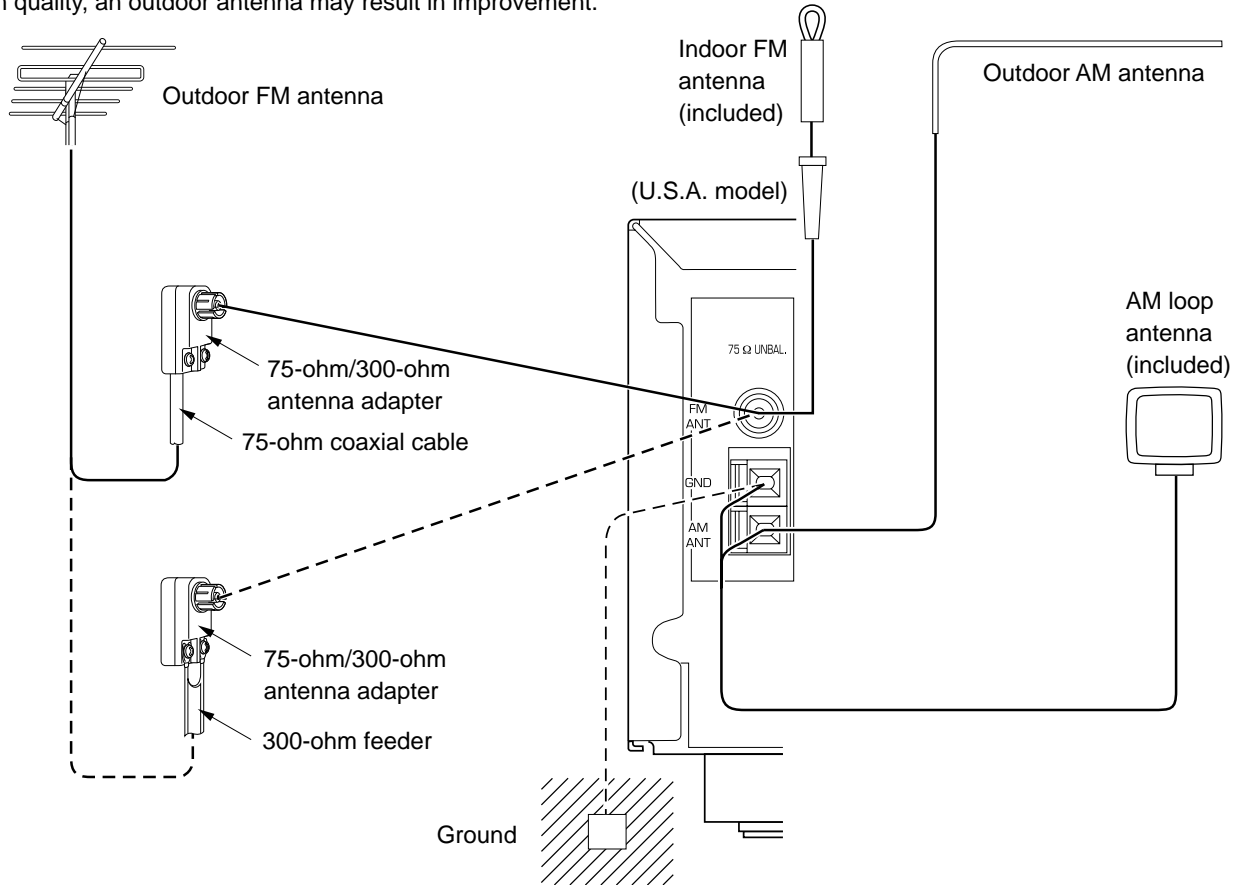

## Connecting the AM loop antenna

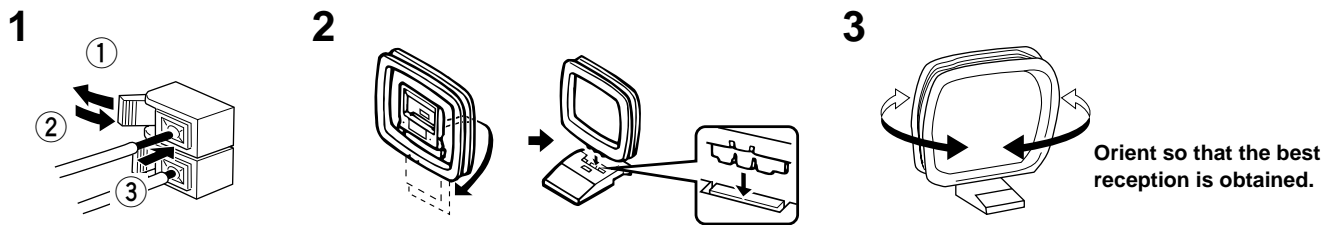

- \* The AM loop antenna should be placed away from this unit. The antenna may be hung on a wall.
- \* The AM loop antenna always should be connected, even if an outdoor AM antenna is connected to this unit.

## GND TERMINAL

For maximum safety and minimum interference, connect the **GND** terminal to a good earth ground. A good earth ground is a metal stake driven into moist earth.

## Notes

- When connecting the indoor FM antenna, firmly insert its connector into the **FM ANT** terminal.
- If you need an outdoor FM antenna to improve FM reception quality, either 300-ohm feeder or coaxial cable may be used. In locations troubled by electrical interference, coaxial cable is preferable.

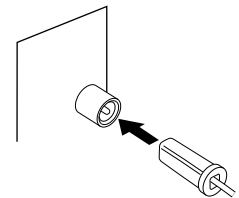

# ADJUSTMENTS BEFORE USING THIS UNIT

## SELECTING THE OUTPUT MODES

This unit provides you the following five functions to determine the method of distributing output signals to speakers suitable for your audio system. When speaker connections have all been completed, select the proper setting for each function to make the best use of your speaker system. (See "ADJUSTMENTS IN THE 'SET MENU' MODE" on page 44.)

- |                                 |                                |                                |
|---------------------------------|--------------------------------|--------------------------------|
| <b>1. CNTR (CENTER SPEAKER)</b> | <b>2. REAR (REAR SPEAKERS)</b> | <b>3. MAIN (MAIN SPEAKERS)</b> |
| <b>4. BASS (LFE/BASS OUT)</b>   | <b>5. M.LVL (MAIN LEVEL)</b>   |                                |

### DESCRIPTION OF EACH FUNCTION

#### CNTR (CENTER SPEAKER)

**Choices:** LARGE/SMALL/NONE

**Preset position:** LARGE

**LARGE:** Select this position when your center speaker is approximately the same size as the main speakers.

**SMALL:** Select this position when you use a center speaker that is smaller than the main speakers.  
In this position, low bass signals (below 90 Hz) on the center channel are output from the main speakers (or the **SUBWOOFER OUTPUT** terminal if the SMALL position is selected for "MAIN" and the SW position is selected for "BASS").

**NONE:** Select this position when you do not have a center speaker. The center channel sound will be output from the left and right main speakers.

#### REAR (REAR SPEAKERS)

**Choices:** LARGE/SMALL

**Preset position:** LARGE

**LARGE:** Select this position if your rear speakers have high ability for bass reproduction, or a subwoofer is connected to the rear speaker in parallel.  
In this position, full-range signals are output from the rear speakers.

**SMALL:** Select this position if your rear speakers do not have high ability for bass reproduction.  
In this position, low bass signals (below 90 Hz) on the rear channels are output from the **SUBWOOFER OUTPUT** terminal (or the main speakers if the MAIN position is selected for "BASS").

#### MAIN (MAIN SPEAKERS)

**Choices:** LARGE/SMALL

**Preset position:** LARGE

**LARGE:** Select this position if your main speakers have high ability for bass reproduction.  
In this position, full-range signals present on the main channels are output from the main speakers.

**SMALL:** Select this position if your main speakers do not have high ability for bass reproduction. However, if your system does not include a subwoofer, do not select this position.  
In this position, low bass signals (below 90 Hz) on the main channels are output from the **SUBWOOFER OUTPUT** terminal if the SW or BOTH position is selected for "BASS".

#### BASS (LFE/BASS OUT)

**Choices:** SW/MAIN/BOTH

**Preset position:** SW

**MAIN:** Select this position if your system does not include a subwoofer.  
In this position, full-range signals present on the main channels, signals from the LFE channel and other low bass signals that are selected for "CNTR" to "MAIN" to be distributed from other channels are output from the main speakers.

**SW/BOTH:**  
Select either the SW or BOTH position if your system includes a subwoofer.  
In either position, signals on the LFE channel and other low bass signals that are selected for "CNTR" to "MAIN" to be distributed from other channels are output from the **SUBWOOFER OUTPUT** terminal. When the LARGE position is selected for "MAIN", in the SW position, no signal is distributed from the main channels to the **SUBWOOFER OUTPUT** terminal; however, in the BOTH position, low bass signals from the main channels are output to both the main speakers and the **SUBWOOFER OUTPUT** terminal.

#### M.LVL (MAIN LEVEL)

**Choices:** NRML (NORMAL)/-10 dB

**Preset position:** NRML (NORMAL)

**NRML (NORMAL):**

Normally select this position.

**-10 dB:** Select this position if the sound output from the main speakers is too loud and cannot be balanced with the sound output from the center and rear speakers. In this position, the sound output from the main speakers is attenuated.

# ADJUSTING METHOD

Adjustments should be made while watching the information on this unit's display.

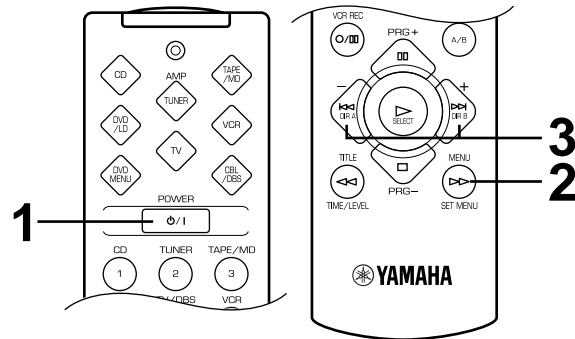
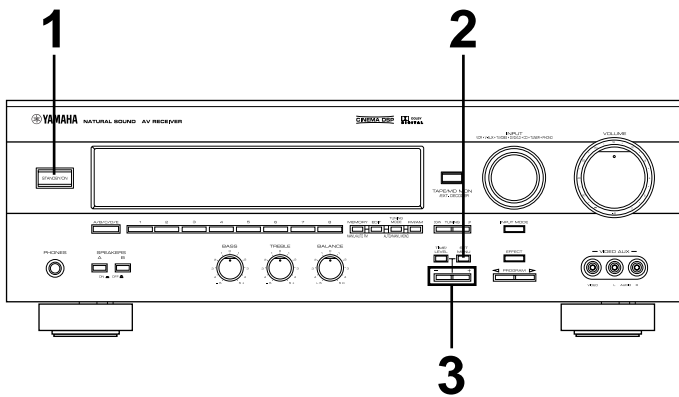

When adjusting with the remote control transmitter, press **AMP<TUNER>** on the component selector on the remote control transmitter.



**3** Press + or – once or more to select the setting you want.

Front panel

Remote control

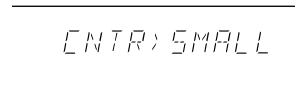
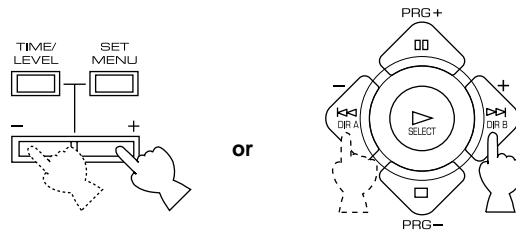

**1** Turn the power on.

Front panel

Remote control

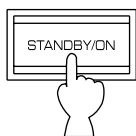

or

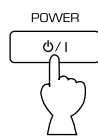

**2** Press **SET MENU** once or more to select the function "CNTR" on the display.

Front panel

Remote control

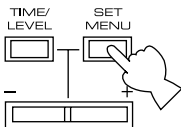

or

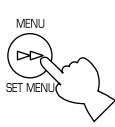

**4** Repeat steps 2 and 3 to change the setting for "REAR", "MAIN", "BASS" and/or "M.LVL" in the same way.



## SPEAKER BALANCE ADJUSTMENT

This procedure lets you adjust the sound output level balance between the main, center and rear speakers by using the built-in test tone generator. When this adjustment is performed, the sound output level heard at the listening position will be the same from each speaker. This is important for the best performance of the digital sound field processor, the Dolby Digital decoder and the Dolby Pro Logic Surround decoder.

**The adjustment of each speaker output level should be done at your listening position with the remote control transmitter. After completing the adjustment of the output level for each speaker, use VOLUME ( ^ v ) on the remote control transmitter at your listening position to check if the adjustments are satisfactory.**

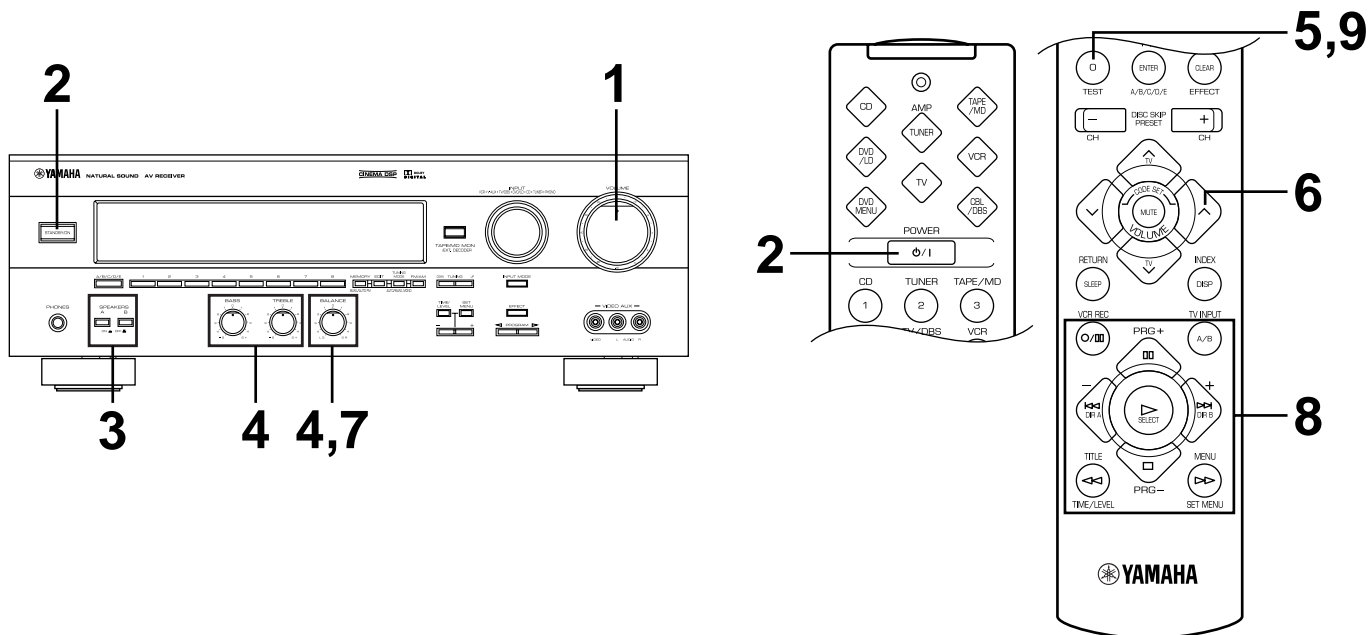

Press **AMP<TUNER>** on the component selector on the remote control transmitter.



**1** Set **VOLUME** to the “∞” position.

**Front panel**

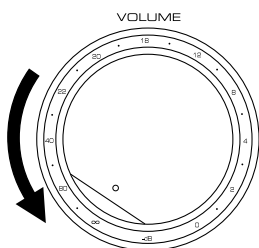

**2** Turn the power on.

**Front panel**

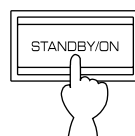

**Remote control**

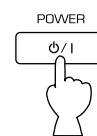

or

**3** Select the main speakers to be used.

**Front panel**

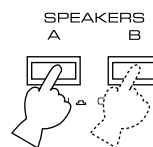

\* If you use two main speaker systems, press both **A** and **B**.

**4** Set **BASS**, **TREBLE** and **BALANCE** to the "0" position.

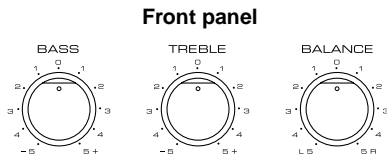

**5** Press **TEST** so that "TEST LEFT" appears on the display.

**Remote control**

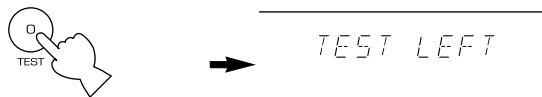

**6** Turn up the volume.

**Remote control**

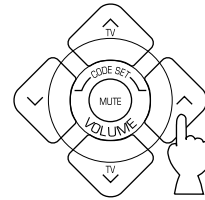

You will hear a test tone (like pink noise) from each speaker for about two seconds in following order: left main speaker, center speaker, right main speaker, right rear speaker and left rear speaker. The display changes as shown below.

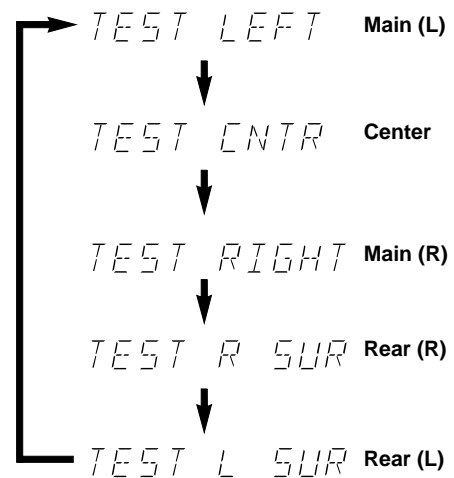

\* If the function "CNTR" in the SET MENU mode is set to the NONE position, you will hear the center channel test tone from the left and right main speakers.

**7** Adjust **BALANCE** so that the sound output level of the left main speaker and the right main speaker is the same.

**Front panel**

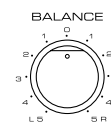

**8** Adjust the sound output levels of the center speaker and the rear speakers so that they become almost the same as that of the main speakers.

Press **TIME/LEVEL** once or more to select the speaker to be adjusted so that "CENTER", "R SUR.", "L SUR." or "SWFR" appears on the display.

**Remote control**



\* You cannot adjust the delay time while the test tone is sounding even if "DELAY" appears on the display after pressing **TIME/LEVEL** once or more.

Adjust the level.

- \* Pressing **+** raises and **-** lowers the level.
- \* While adjusting, the test tone is fixed on the selected speaker.

**Remote control**

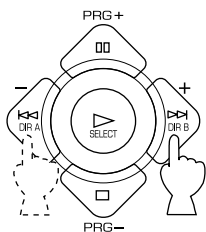

**Notes**

- Once you have completed these adjustments, you can only adjust the overall sound level of your audio system by using **VOLUME** (or **VOLUME** ( ^ v ) on the remote control transmitter).
- If you use external power amplifiers, you may also use their volume controls to achieve the proper balance.
- If the function "CNTR" in the SET MENU mode is set to the NONE position, the sound output level of the center speaker cannot be adjusted in step 8. The center sound is automatically output from the left and right main speakers.
- If there is insufficient sound output from the center and rear speakers, you may decrease the main speaker output level by setting "M.LVL" to "-10 dB".

**9** Press **TEST** again to stop the test tone.

**Remote control**

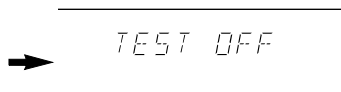
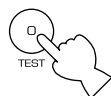

# BASIC OPERATIONS

## TO PLAY A SOURCE

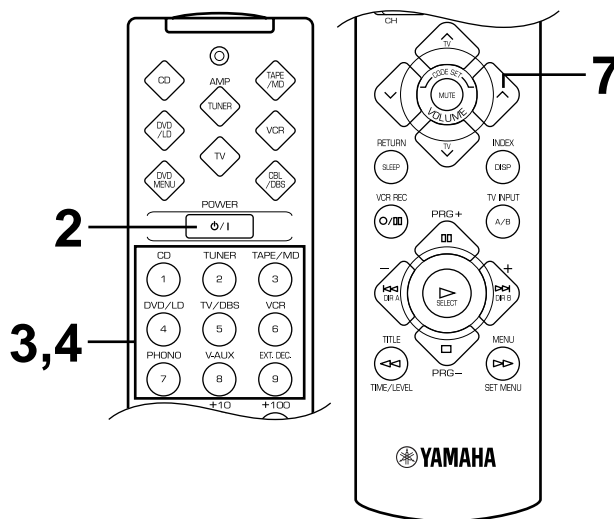
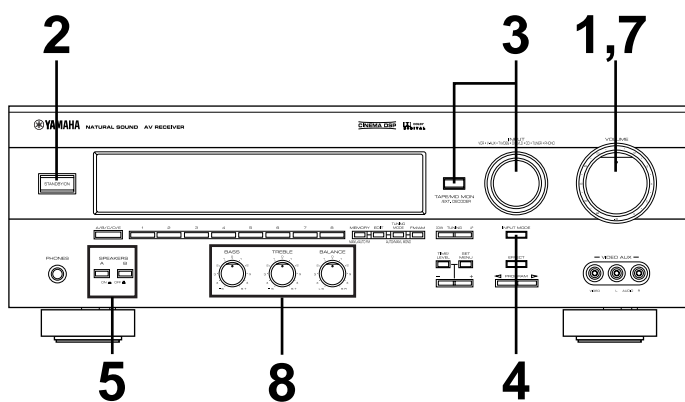

### When using the remote control transmitter

- Press **AMP<TUNER>** on the component selector.
- When controlling an audio/visual component (tape deck, MD recorder, CD player, DVD/LD player, etc.), press the button on the component selector, **TAPE/MD**, **CD**, **DVD/LD**, etc., for the component you want to control. (See "SETUP CODES" on page 53.)

**1** Set **VOLUME** to the "∞" position.

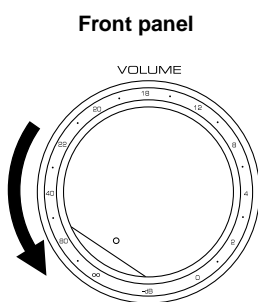

**2** Turn the power on.

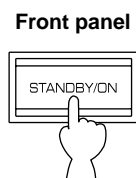

or

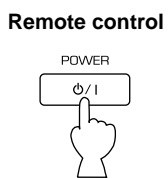

**3** Select the desired program source by using **INPUT**.  
(Turn on the TV/monitor for video sources.)

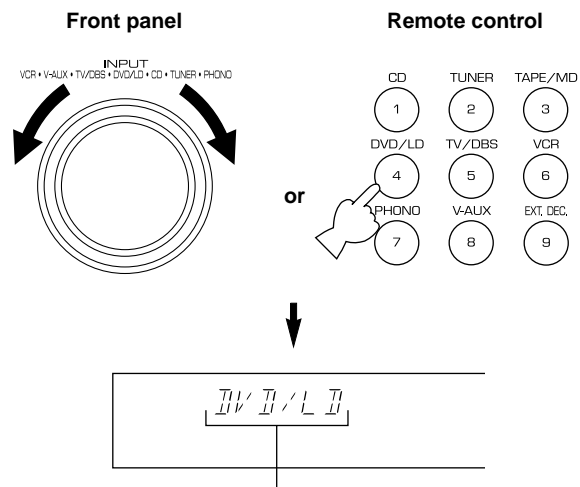

The name of the selected program source will appear on the display.

### To play a tape or an MD

Press **TAPE/MD MON / EXT. DECODER** on the front panel or **TAPE/MD** on the remote control transmitter so that the "TAPE/MD MON" indicator lights up on the display.

### Front panel

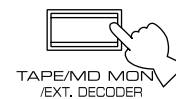

### To use a decoder connected to the EXTERNAL DECODER INPUT terminals

Press **TAPE/MD MON / EXT. DECODER** once or more on the front panel or **EXT. DEC.** on the remote control transmitter so that "EXT. DECDR" appears on the display.

**4** For a DVD/LD or TV/DBS source, the current input mode is also shown.  
 \* To change the input mode for the DVD/LD or TV/DBS source, press **INPUT MODE** (or the button that you have pressed to select the program source in step 3 on the remote control transmitter) once or more until the desired input mode (AUTO or ANALOG) is shown on the display. (See page 30 for details on switching the input mode.)

**Front panel**

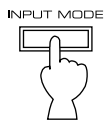

**Remote control**

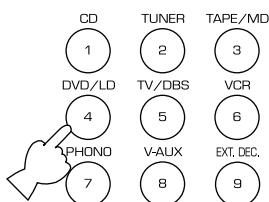

or

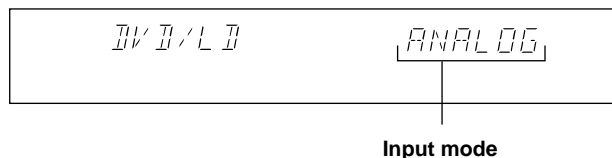

**5** Select the main speakers to be used.

**Front panel**

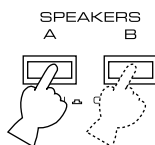

\* If you use two main speaker systems, press both **A** and **B**.

**6** Play the source. (See page 32 for detailed information on tuning.)

**7** Adjust the volume to the desired output level.

**Front panel**

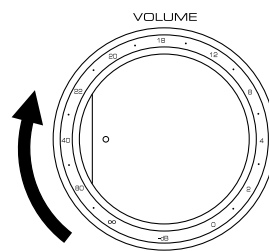

**Remote control**

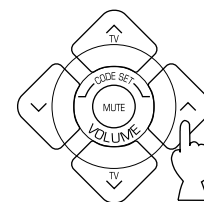

or

**8** If desired, adjust **BASS**, **TREBLE**, **BALANCE**, etc. and use the digital sound field processor (see page 38).

**BASS:** Turn this control clockwise to increase (or counterclockwise to decrease) the low-frequency response.

**TREBLE:** Turn this control clockwise to increase (or counterclockwise to decrease) the high-frequency response.

**BALANCE:** Adjust the balance of the output volume from the left and right speakers to compensate for sound imbalance caused by the speaker location or listening room conditions.

**Front panel**

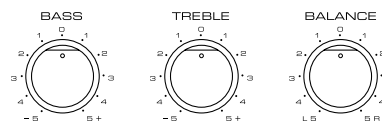

\* These controls are only effective for the sound from the main speakers.

**When you have finished using this unit**

Press **STANDBY/ON** on the front panel again or **POWER** on the remote control transmitter to set this unit to the standby mode.

## Notes on using INPUT

- The audio source selected by **INPUT** will not be played if the "TAPE/MD MON" indicator lights up or if "EXT. DECDR" is displayed.
- If you select **INPUT** for a video source without canceling the selection of **TAPE/MD MON / EXT. DECODER** on the front panel (or **TAPE/MD** or **EXT. DEC.** on the remote control transmitter), the play back result will be a video image from the video source and the sound from the audio source selected by **TAPE/MD MON / EXT. DECODER** on the front panel (or **TAPE/MD** or **EXT. DEC.** on the remote control transmitter).
- Once you start playing a video source, the video image will not be interrupted even if **INPUT** for an audio source is selected.
- When you select a program source by using **INPUT**, the DSP program (or no DSP program) that was being used when the same program source was selected the last time, will be automatically recalled.

## Switching the input mode (for DVD/LD and TV/DBS)

This unit allows you to switch the input mode only for those sources connected to the DVD/LD and TV/DBS input terminals (on the rear panel of this unit) that input two or three types of signal.

The following two input modes are provided:

### **AUTO For a source connected to the DVD/LD input terminals**

This mode is automatically selected when you turn on the power to this unit. In this mode, the input signal is automatically selected in the following order of priority:

1. Digital input signal from the **COAXIAL** terminal
2. Digital input signal from the **OPTICAL** terminal
3. Analog input signal

### **For a source connected to the TV/DBS input terminals**

This mode is selected when you turn on the power to this unit if the AUTO position is selected for "INPUT" in the SET MENU mode. (See page 45 for details.) In this mode, the input signal is automatically selected in the following order of priority:

1. Digital input signal from the **OPTICAL** terminal
2. Analog input signal

### **ANALOG**

In this mode, only an analog input signal is selected, even if a digital signal is input at the same time. Select this mode when you want to use the analog input signal instead of the digital input signal.

### **Notes on input mode selection**

- To play back a source that is Dolby Digital-decoded, set the input mode to AUTO.
- For the TV/DBS source only, the input mode selected for "INPUT" in the SET MENU mode is effective when you turn on the power to this unit.
- When you want to enjoy a source which has normal 2-channel signals with a Dolby Pro Logic Surround program, select the ANALOG mode.
- In the AUTO mode, there may be a case, depending on the LD player or DVD player, that when you search for a source encoded with Dolby Digital during play and then play is restored, the sound output is interrupted for a moment because the digital input signal is selected again.

# TO RECORD A SOURCE ON TAPE OR MD

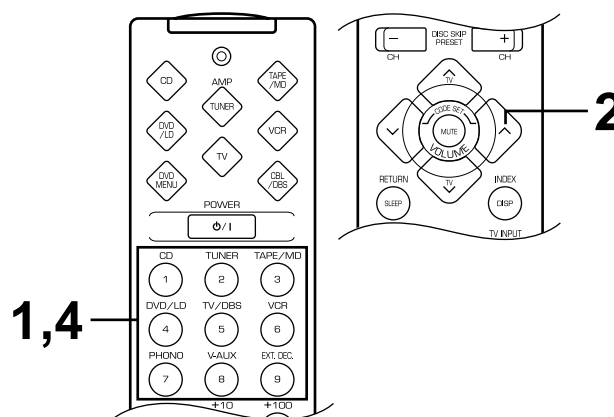
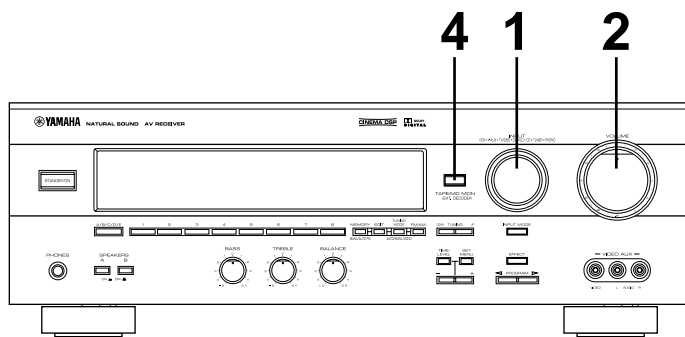

**1** Select the source to be recorded.

**Front panel**  
 INPUT  
 VCR • V-AUX • TV/DBS • DVD/LD • CD • TUNER • PHONO

**Remote control**

CD	TUNER	TAPE/MD
1	2	3
DVD/LD	TV/DBS	VCR
4	5	6
PHONO	V-AUX	EXT. DEC.
7	8	9

or

**2** Play the source and then turn up the volume to confirm the program source. (See page 32 for detailed information on tuning.)

**Front panel**  
 VOLUME

**Remote control**

or

**3** Begin recording on the tape deck, MD recorder or VCR connected to this unit.

**4** When a tape deck or MD recorder is being used for recording, you can monitor the sounds being recorded by pressing **TAPE/MD MON / EXT. DECODER** on the front panel or **TAPE/MD** on the remote control transmitter so that the "TAPE/MD MON" indicator lights up on the display.

**Front panel**  
 TAPE/MD MON / EXT. DECODER

or

**Remote control**  
 TAPE/MD

- Notes**
- The settings of DSP and **VOLUME, BASS, TREBLE** and **BALANCE** have no effect on the material being recorded.
  - A source that is connected to this unit only through the digital terminals cannot be recorded by a tape deck, MD recorder or VCR connected to this unit.
  - Please check the copyright laws in your country to record from records, compact discs, radio, etc. Recording of copyright material may infringe copyright laws.

If you use a video source that has scrambled or encoded signals to prevent it from being dubbed, there may be a case that the picture itself will be affected by those signals.

# TUNING OPERATIONS

Set **INPUT** on the front panel to the **TUNER** position. When using the remote control transmitter, press **AMP<TUNER>** on the component selector and then press **TUNER** on the input selector.

Normally, if station signals are strong and there is no interference, quick automatic-search tuning (AUTOMATIC TUNING) is possible. However, if the signal from the station you want to select is weak, you must tune in to it manually (MANUAL TUNING).

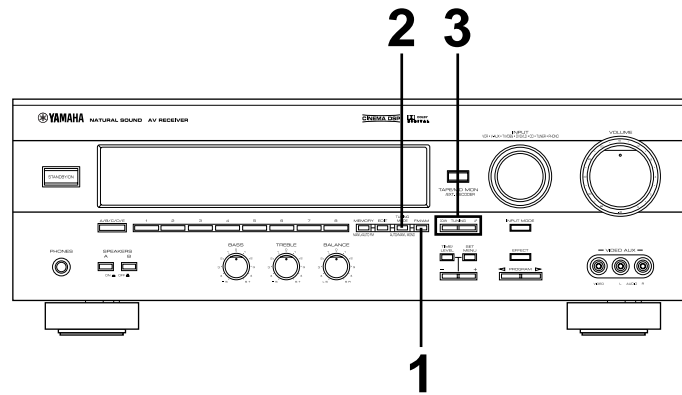

## AUTOMATIC TUNING

- 1 Select the reception band (FM or AM) and confirm it on the display.

Front panel

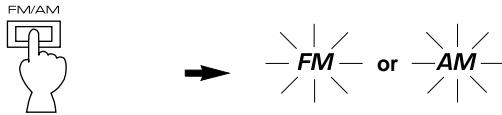

- 2 Press **TUNING MODE** so that the "AUTO TUNING" indicator lights up on the display.

Front panel

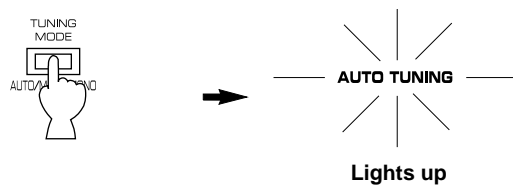

- 3 To tune in to a higher frequency, press the UP side of **TUNING** once.  
To tune in to a lower frequency, press the DOWN side of **TUNING** once.

Front panel

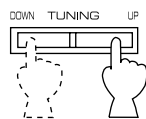

- \* If the station where the tuning search stops is not the desired one, press once more.
- \* If the tuning search does not stop at the desired station (because the signal from the station is weak), take the manual tuning procedure.

## MANUAL TUNING

- 1 Select the reception band (FM or AM) and confirm it on the display.

Front panel

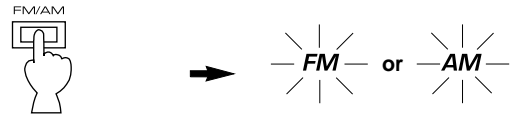

- 2 Press **TUNING MODE**.

Front panel



- 3 Tune in manually to the desired station.

Front panel

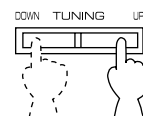

- \* To continue the tuning search, press and hold the button.

### Note

If you tune in manually to an FM station, it will be automatically received in monaural mode to increase the signal quality.



## MANUAL PRESET TUNING

This unit can store station frequencies to be selected by tuning. With this function, you can recall any desired station simply by selecting the preset station number with which it was stored. Up to 40 stations (8 stations x 5 groups) can be stored.

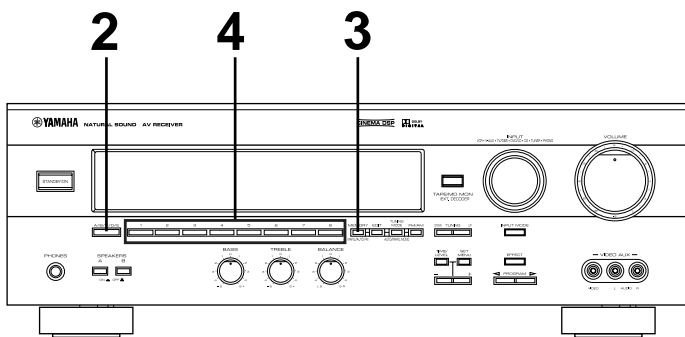

### To store stations

**1** Tune in to the desired station.  
(See the previous page for the tuning procedure.)

**2** Press **A/B/C/D/E** once or more to select the desired group (A to E) of preset stations and confirm it on the display.

**Front panel**

**3** Press **MEMORY** so that the “MEMORY” indicator flashes for about five seconds.

**Front panel**

**4** Select the preset station number with which you want to store the station before the “MEMORY” indicator goes off from the display.

**Front panel**

**The displayed station has been stored as A1.**

- \* In the same way, store other stations as A2, A3 ... A8.
- \* You can store more stations as preset station numbers in other groups in the same way by selecting another group in step 2.

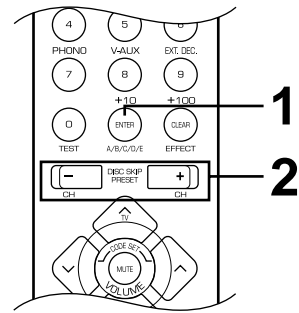
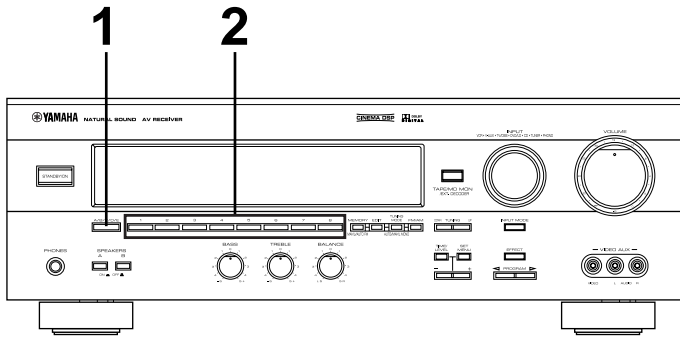

### To recall a preset station

**1** Select the group of preset stations.

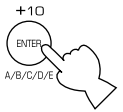
**Front panel**  **Remote control** 

**2** Select the preset station number.

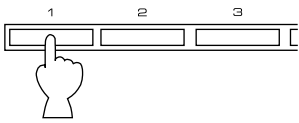
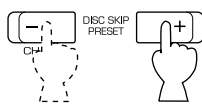
**Front panel**  **Remote control** 

#### Notes

- A new setting can be stored in place of the former one.
- For presets, the setting of the reception mode (stereo or monaural) is stored along with the station frequency.

#### Memory back-up

The memory back-up circuit prevents the stored data from being lost when this unit is set in the standby mode. If, however, the power plug is disconnected from the AC outlet or the power is cut due to temporary power failure for more than one week, the memory will be erased. If so, it can be re-stored by simply following the preset tuning procedure.

## AUTOMATIC PRESET TUNING (for FM stations only)

You can also make use of the automatic preset tuning function for FM stations only. This function enables the unit to perform automatic tuning and to sequentially store FM stations with strong signals. Up to 40 stations can be stored automatically in the same way as that for manual preset tuning on page 33. Note that a new setting can be stored in place of the former one.

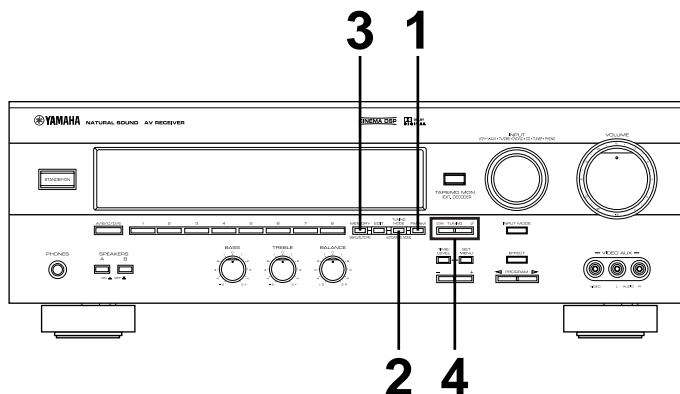

### To store stations

- 1** Select the FM band.

Front panel



- 2** Press **TUNING MODE** so that the “AUTO TUNING” indicator lights up on the display.

Front panel

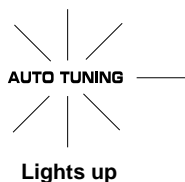
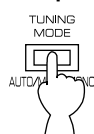

Lights up

- 3** Press **MEMORY** and hold for about three seconds.

Front panel

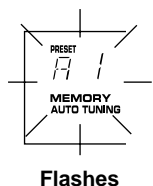

Flashes

- 4** To tune in to higher frequencies, press the UP side of **TUNING** once.  
To tune in to lower frequencies, press the DOWN side of **TUNING** once.

Front panel

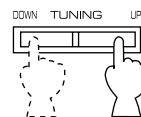

- \* If **TUNING** is not pressed, the automatic preset tuning soon begins automatically toward higher frequencies.

Automatic preset tuning begins from the frequency currently displayed. Received stations are sequentially stored as A1, A2 ... A8.

- \* If more than 8 stations are received, they are stored as the preset station numbers in other groups (B, C, D and E) in that order.

### If you want to store the first station received by automatic preset tuning as a desired preset station number

For example, if you want to store the first received station as C5, select “C5” while “A1”, the “MEMORY” indicator and the “AUTO TUNING” indicator flash after pressing **MEMORY** in step 3. Then press **TUNING**. The first received station is stored as C5, and the next stations as C6, C7 ... sequentially.

If stations have been stored up to E8, automatic preset tuning automatically stops.

### When automatic preset tuning is complete

The display shows the frequency of the last preset station. Check the contents and the number of preset stations by following the procedure in the section “To recall a preset station” on page 34.

### Notes

- You can manually replace a preset station with another FM or AM station by simply following the procedure in the section “To store stations” on page 33.
- Even if the number of received stations is not enough to be stored up to E8, the search is automatically ended after searching all frequencies.
- With this function, only FM stations with sufficient signal strength are automatically stored. If the station you want to store is weak in signal strength, tune in to it manually in monaural sound and store it by following the procedure in the section “To store stations” on page 33.

## EXCHANGING PRESET STATIONS

You can exchange the assignment of two preset stations with each other as shown below.

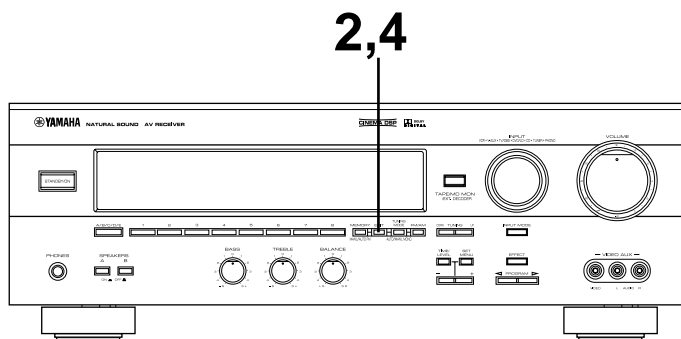

### Example

If you want to change the preset station from “E1” to “A5”, or vice versa.

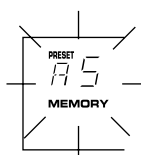
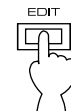
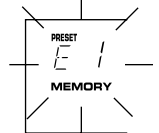
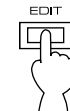
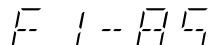
<p><b>1</b> Recall preset station “E1” by following the procedure in the section “To recall a preset station” on page 34.</p>	<p><b>3</b> Next, recall preset station “A5” by following the same procedure as in step 1.</p>  <p>Flashes</p>
<p><b>2</b> Press <b>EDIT</b>.</p> <p>Front Panel</p>  <p>→</p>  <p>Flashes</p>	<p><b>4</b> Press <b>EDIT</b> once more.</p> <p>Front Panel</p>  <p>→</p>  <p>Shows the exchange of stations has been completed.</p>

# SETTING THE SLEEP TIMER

The SLEEP timer can be used to make this unit automatically switch to the standby mode. When you are going to sleep while enjoying a broadcast or other desired program source, this timer function is useful. The SLEEP timer can only be controlled with the remote control transmitter.

**Notes**

- To set the SLEEP timer for this unit, press **AMP<TUNER>**, **TAPE/MD**, **CD** or **DVD/LD** on the component selector.
- The components for which the SLEEP timer is effective are the sources connected to the **SWITCHED AC OUTLET(S)** on the rear panel of this unit.

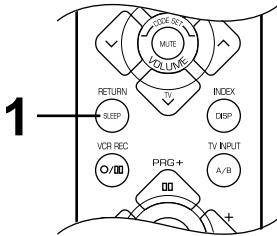

### To set the SLEEP time

**1** Press **SLEEP** once or more to select the desired SLEEP time.

**Remote control**

↓

**The SLEEP time is displayed.**

**Flashes**

Each time you press **SLEEP**, the SLEEP time will change as follows:

(Minutes)

120 → 90 → 60 → 30

The SLEEP timer is off (SLEEP OFF).  
(This is the state before SLEEP is pressed.)

The "SLEEP" indicator soon lights up and the display returns to the indication before the SLEEP timer was set.

### To cancel the selected SLEEP time

**Remote control**

Press **SLEEP** once or more so that "SLEEP OFF" appears on the display. (It will soon disappear and the "SLEEP" indicator will go off from the display.)

**Note**  
The SLEEP timer setting can also be canceled by setting the unit in the standby mode with **STANDBY/ON** on the front panel (or **POWER** on the remote control transmitter) or by disconnecting the power plug of the unit from the AC outlet.

**2** The unit will be switched to the standby mode automatically at the selected SLEEP time.

# USING THE DIGITAL SOUND FIELD PROCESSOR (DSP)

This unit incorporates a sophisticated, multi-program digital sound field processor. The processor allows you to electronically expand and change the shape of the audio sound field from both audio and video sources, creating a theater-like experience in your listening room. You can create outstanding audio sound by selecting a suitable sound field program (this will, of course, depend on what you are listening to) and adding any desired adjustments.

The following list gives you a brief description of the sound fields produced by each of the DSP programs. Keep in mind that most of these are precise digital re-creations of actual acoustic environments. The data for these sound fields were recorded at actual locations using sophisticated sound field measurement equipment.

## Note

The channel level balance between the left and right rear speakers may vary depending on the sound field you are listening to. This is due to the fact that most of these sound fields are a re-creation of actual acoustic environments.

## BRIEF OVERVIEW OF DIGITAL SOUND FIELD PROGRAMS

No.	PROGRAM	FEATURES
1	<p><b>DOLBY PRO LOGIC ( <input type="checkbox"/> PRO LOGIC )</b>            This functions when the input signal is analog or PCM audio, or encoded with Dolby Digital in 2-channel.            Speaker output: main, center, rear</p> <p><b>DOLBY DIGITAL ( <input type="checkbox"/> DIGITAL )</b>            This functions when the input signal is encoded with Dolby Digital (not in 2-channel).            Speaker output: main, center, rear</p>	<p>This reproduces video discs, video tapes and similar sources which are Dolby Surround encoded and bear the "DOLBY SURROUND" logo.</p> <p>The built-in Dolby Pro Logic Surround decoder or Dolby Digital decoder precisely reproduces the sounds and sound effects of a source encoded with Dolby Surround. The realization of a highly efficient decoding process improves crosstalk and channel separation and makes sound positioning smoother and more precise.</p> <p><b>Note:</b> If the main channel sound is considerably altered by overadjusting <b>BASS</b> or <b>TREBLE</b>, it may not produce suitable surround sound.</p>
2	<p><b>DOLBY PRO LOGIC ENHANCED ( <input type="checkbox"/> DSP <input checked="" type="checkbox"/> PRO LOGIC )</b>            This functions when the input signal is analog or PCM audio, or encoded with Dolby Digital in 2-channel.            Speaker output: main, center, rear</p> <p><b>DOLBY DIGITAL ENHANCED ( <input type="checkbox"/> DIGITAL <input type="checkbox"/> DSP )</b>            This functions when the input signal is encoded with Dolby Digital (not in 2-channel).            Speaker output: main, center, rear</p>	<p>This reproduces video discs, video tapes and similar sources which are Dolby Surround encoded and bear the "DOLBY SURROUND" logo.</p> <p>This program ideally simulates the multi-surround speaker systems of the 35 mm film theater. Dolby Surround decoding is precisely performed without altering the original sound orientation. The surround effects produced by this sound field fold around the viewer naturally from the rear to the left and right and toward the screen.</p>
3	<p><b>70 mm MOVIE THEATER ( <input type="checkbox"/> DSP <input checked="" type="checkbox"/> PRO LOGIC )</b>            This functions when the input signal is analog or PCM audio, or encoded with Dolby Digital in 2-channel.            Speaker output: main, center, rear</p> <p><b>DIGITAL MOVIE THEATER ( <input type="checkbox"/> DIGITAL <input type="checkbox"/> DSP )</b>            This functions when the input signal is encoded with Dolby Digital (not in 2-channel).            Speaker output: main, center, rear</p>	<p>This is ideal for reproducing video discs, video tapes and similar sources which are Dolby Surround encoded and bear the "DOLBY SURROUND" logo.</p> <p>This program is ideal for precisely reproducing the sound design of the newest 70 mm/Dolby Digital multi-track films. The sound field is similar to that of the newest movie theaters, so the reverberations of the sound field itself are restrained as much as possible. The three-dimensional feeling of the sound field is emphasized, and dialog is precisely oriented on the screen. You can enjoy watching Sci-Fi, adventure movies, etc. with considerable presence.</p>

No.	PROGRAM	FEATURES
4	<p><b>MONO MOVIE</b> ( <input type="checkbox"/> <b>DSP</b> )</p> <p>This functions when the input signal is analog or PCM audio, or encoded with Dolby Digital in 2-channel. Speaker output: main, center, rear</p> <p>( <input checked="" type="checkbox"/> <b>DIGITAL</b> <input type="checkbox"/> <b>DSP</b> )</p> <p>This functions when the input signal is encoded with Dolby Digital (not in 2-channel). Speaker output: main, center, rear</p>	<p>This program is designed specifically to enhance mono audio sources. Compared to a strictly mono setting, the sound image created in this mode is wider and slightly forward of the speaker pair, lending an immediacy to the overall sound. It is particularly effective when used with old mono movies, news broadcasting and dialog.</p>
5	<p><b>TV SPORTS</b> ( <input type="checkbox"/> <b>DSP</b> )</p> <p>This functions when the input signal is analog or PCM audio, or encoded with Dolby Digital in 2-channel. Speaker output: main, center, rear</p> <p>( <input checked="" type="checkbox"/> <b>DIGITAL</b> <input type="checkbox"/> <b>DSP</b> )</p> <p>This functions when the input signal is encoded with Dolby Digital (not in 2-channel). Speaker output: main, center, rear</p>	<p>This program is furnished with a tight sound field in which the sound will not spread excessively on the front side, but the rear surround side produces dynamic sound expansion. This program is the most suitable for sports events.</p>
6	<p><b>DISCO</b> ( <input type="checkbox"/> <b>DSP</b> )</p> <p>This functions when the input signal is analog or PCM audio, or encoded with Dolby Digital in 2-channel. Speaker output: main, rear</p> <p>( <input checked="" type="checkbox"/> <b>DIGITAL</b> <input type="checkbox"/> <b>DSP</b> )</p> <p>This functions when the input signal is encoded with Dolby Digital (not in 2-channel). Speaker output: main, center, rear</p>	<p>This program re-creates the acoustic environment of a lively disco in the heart of a very lively city. The sound is dense and highly concentrated. It is also characterized by a high-energy, "immediate" sound.</p>
7	<p><b>ROCK CONCERT</b> ( <input type="checkbox"/> <b>DSP</b> )</p> <p>This functions when the input signal is analog or PCM audio, or encoded with Dolby Digital in 2-channel. Speaker output: main, rear</p> <p>( <input checked="" type="checkbox"/> <b>DIGITAL</b> <input type="checkbox"/> <b>DSP</b> )</p> <p>This functions when the input signal is encoded with Dolby Digital (not in 2-channel). Speaker output: main, center, rear</p>	<p>This program is ideally suited for rock music. You will experience a very dynamic and lively sound field.</p>
8	<p><b>CONCERT HALL</b> ( <input type="checkbox"/> <b>DSP</b> )</p> <p>This functions when the input signal is analog or PCM audio, or encoded with Dolby Digital in 2-channel. Speaker output: main, rear</p> <p>( <input checked="" type="checkbox"/> <b>DIGITAL</b> <input type="checkbox"/> <b>DSP</b> )</p> <p>This functions when the input signal is encoded with Dolby Digital (not in 2-channel). Speaker output: main, center, rear</p>	<p>In this program, the center will appear to be deep behind the main speakers, creating an expansive, large hall ambience. Orchestra and opera music are suited to this sound field.</p>

**Note:** When the NONE position is selected for "CNTR" in the SET MENU mode, no sound is output from the center speaker(s).

# PLAYING AN AUDIO/VIDEO SOURCE WITH THE DIGITAL SOUND FIELD PROCESSOR (DSP) EFFECT

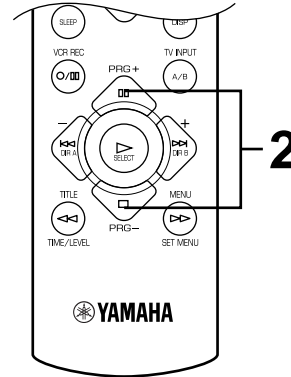
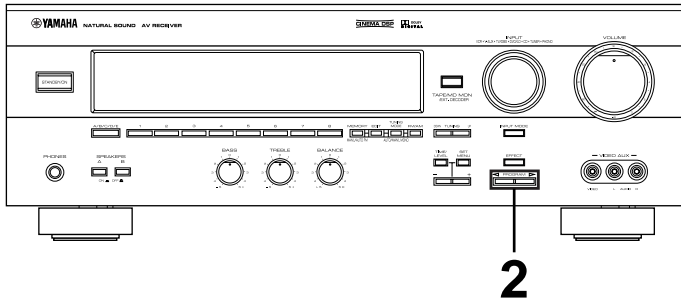

**1** Follow steps 1 to 7 shown in “BASIC OPERATIONS” on pages 28 to 29.

**2** Select the desired DSP program that is suitable for the source. When using the remote control transmitter, press **AMP<TUNER>** on the component selector first.

**Front panel**

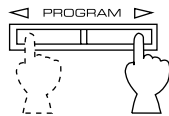

**Remote control**

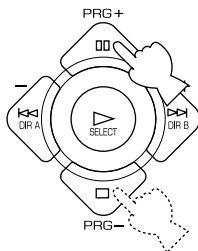

or

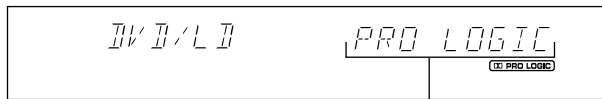

The name of the selected program appears on the display.

**3** If desired, adjust the delay time and the output level of each speaker. (See pages 42 and 43 for details.)

**Notes**

- You can select a program for each of the program sources. Once you select a program, it is linked with the program source selected at that time. So, when you select the program source next time, the same program is automatically called.
- If you prefer to cancel the DSP function, press **EFFECT**. The sound will be that of normal 2-channel stereo without a surround sound effect.
- When a monaural sound source is played with **DOLBY PRO LOGIC** or **DOLBY PRO LOGIC ENHANCED**, no sound can be heard from the main speakers and the rear speakers. Sound is heard only from the center speaker. However, if the **NONE** position is selected for “CNTR” in the SET MENU mode, the main speakers output the sound of the center channel.



This unit incorporates a Dolby Digital decoder and a Dolby Pro Logic Surround decoder for multi-channel sound reproduction of sources encoded with Dolby Surround. The operation of these decoders can be controlled by selecting a corresponding DSP program including the combined operation of YAMAHA DSP and Dolby Digital or Dolby Pro Logic Surround.

## To enjoy a video source with Dolby Pro Logic Surround or Dolby Digital-decoded

When you select the **DOLBY PRO LOGIC/DOLBY DIGITAL**, **DOLBY PRO LOGIC ENHANCED/DOLBY DIGITAL ENHANCED** or **70 mm MOVIE THEATER/DIGITAL MOVIE THEATER** program, and the input signal of the source is 2-channel stereo, Dolby Pro Logic Surround is decoded. When a program is selected and the input signal of the source is encoded with Dolby Digital, Dolby Digital is automatically decoded.

- \* The following indicators on the display show you what sound processing is being undertaken.

This lights up when Dolby Digital is being decoded and the input signal of the selected source encoded with Dolby Digital is not in 2-channel.

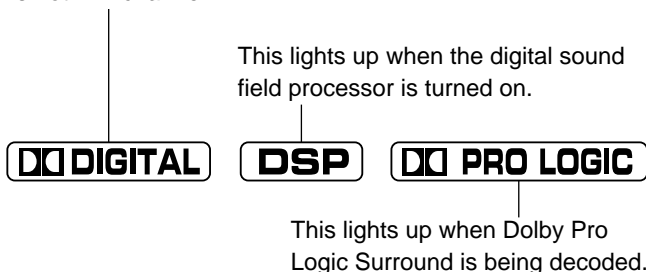

- \* In addition, for the **DOLBY PRO LOGIC/DOLBY DIGITAL**, **DOLBY PRO LOGIC ENHANCED/DOLBY DIGITAL ENHANCED** or **70 mm MOVIE THEATER/DIGITAL MOVIE THEATER** program, the name of the program on the display will change according to the type of decoding. (See page 38 for details.)

### Note

If the input signal of the source is encoded with Dolby Digital in 2-channel only, their sound processing is similar to that for analog or PCM audio signals.

## To cancel the sound effect

**EFFECT** on the front panel and on the remote control transmitter make it simple to compare the normal stereo sound with the fully processed sound effect.

To cancel the sound effect and monitor only the main sound, press **EFFECT**. Press **EFFECT** once more to turn sound effect on.

### Front panel

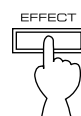

or

### Remote control

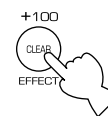

### Notes

- If the sound effect is canceled when signals encoded with Dolby Digital are input to this unit, the signals of all channels are mixed and are output from the main speakers.
- If **EFFECT** is pressed to turn sound effects off when Dolby Digital is decoded, it may happen that the sound is output faintly or not output normally, depending on the source. In that case, press **EFFECT** to turn sound effects on, or use input signals not encoded with Dolby Digital.

# ADJUSTING THE DELAY TIME AND SPEAKER OUTPUT LEVELS

When using the digital sound field processor with the Dolby Pro Logic Surround decoder or the Dolby Digital decoder, you can adjust the delay time between the main sound and sound effect, and each speaker's output level as you prefer.

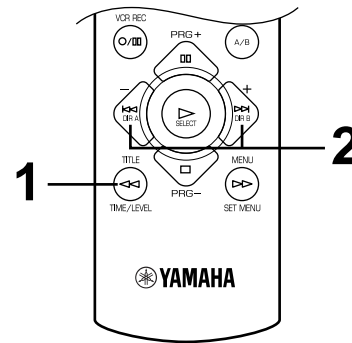
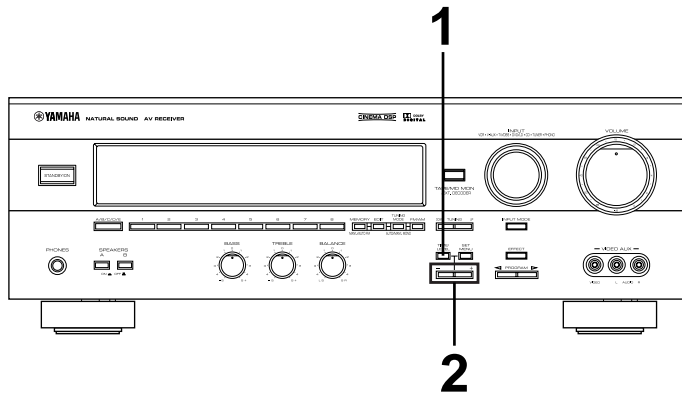

## Adjusting method

When adjusting with the remote control transmitter, press **AMP<TUNER>** on the component selector.



**2** Press **+** or **-** to adjust the settings for the delay time or speaker output levels.

**Front panel**

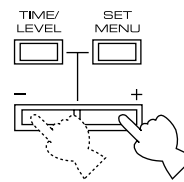

**Remote control**

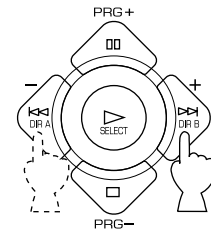

**1** Press **TIME/LEVEL** once or more until the name of the item which you want to adjust appears on the display.

**Front panel**

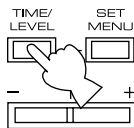

**Remote control**

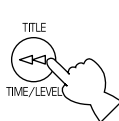

When pressed, the selection changes as follows:

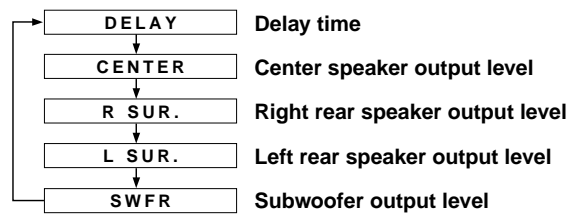

\* Depending on the setting in the SET MENU mode, you may not be able to select all items.

**3** Repeat steps 1 to 2 to adjust the settings of any other item.

## Adjusting the delay time

You can adjust the time difference between the beginning of the sound from the main speakers and the beginning of the sound effect from the rear speakers.

The larger the value, the later the sound effect is generated.

This adjustment can be individually made to all programs.

### Notes

- Adding too much delay will cause an unnatural effect with some sources.
- When + or – is pressed, the sound is momentarily interrupted.

Program	Control range (ms)	Preset value
1. DOLBY PRO LOGIC	15 to 30	20
DOLBY DIGITAL	0 to 15	5
2. DOLBY PRO LOGIC ENHANCED	15 to 30	20
DOLBY DIGITAL ENHANCED	0 to 15	5
3. 70 mm MOVIE THEATER	15 to 30	20
DIGITAL MOVIE THEATER	1 to 99	16
4. MONO MOVIE	1 to 99	49
5. TV SPORTS	1 to 99	9
6. DISCO	1 to 99	40
7. ROCK CONCERT	1 to 99	16
8. CONCERT HALL	1 to 99	44

## Adjusting the output level of the center, right rear and left rear speakers, and subwoofer

If desired, you can adjust the sound output level of each speaker even if the output level has already been set in "SPEAKER BALANCE ADJUSTMENT" on pages 25 to 27.

### Notes

- The output level of the center speaker cannot be adjusted when the **DISCO**, **ROCK CONCERT** or **CONCERT HALL** program is selected, and the input signal is analog, PCM audio, or encoded with Dolby Digital in 2-channel format.

- If the function "CNTR" in the SET MENU mode is set to the NONE position, the sound output level of the center speaker cannot be adjusted. This is because, in this mode, the center sound is automatically output from the left and right main speakers.
- Once the output level has been adjusted, the level will be the same for all digital sound field programs.

Speakers	Control range (dB)	Preset value
CENTER	MIN, –20 to +10	0
RIGHT REAR	MIN, –20 to +10	0
LEFT REAR	MIN, –20 to +10	0
SUBWOOFER	MIN, –20 to 0	0

## Memory back-up

The memory back-up circuit prevents the stored data from being lost when this unit is set in the standby mode. If, however, the power plug is disconnected from the AC outlet or the power is cut due to temporary power failure for more than one week, the values for the delay time and the center/rear/subwoofer output levels you set the last time will automatically return to the preset values. If so, they can be re-set by simply following the adjusting method on page 42.

# ADJUSTMENTS IN THE “SET MENU” MODE

The following ten types of functions maximize the performance of your system and expand your enjoyment for audio listening and video watching.

1. **CNTR (CENTER SPEAKER)**
2. **REAR (REAR SPEAKERS)**
3. **MAIN (MAIN SPEAKERS)**
4. **BASS (LFE/BASS OUT)**
5. **M.LVL (MAIN LEVEL)**
6. **LFE (LFE LEVEL)**
7. **D.RNG (DYNAMIC RANGE)**
8. **C.DELAY (CENTER DELAY)**
9. **GUARD (MEMORY GUARD)**
10. **INPUT (INPUT MODE)**

For details on “CNTR”, “REAR”, “MAIN”, “BASS” and “M.LVL”, see page 23. (Once you have selected the appropriate modes, you do not have to change settings unless any alteration is made in your speaker system.)

## LFE [Adjusting the output level of the LFE (low frequency effect) channel]

**Control range: –20 dB to 0 dB (in 1 dB steps)**  
**Preset value: 0 dB**

\* This adjustment is effective only when Dolby Digital is decoded and the signals of the selected source encoded with Dolby Digital contain LFE signals.

This adjusts the output level of the LFE channel. If the LFE signals are mixed with signals of other channels to output them from the same speakers, the ratio of the LFE signal level to the level of the other signals is adjusted.  
(See page 7 for details about the LFE channel.)

## D.RNG (Adjusting the dynamic range)

**Choices: MAX/STD/MIN**  
**Preset position: MAX**

\* This adjustment is effective only when Dolby Digital is decoded.

**MAX:** “Dynamic range” is the difference between the maximum level and the minimum level of sounds. Sounds on a movie originally designed for movie theaters feature very wide dynamic range. Dolby Digital technology can modify the original sound track into a home audio format with this wide dynamic range unchanged.  
In this position, a source encoded with Dolby Digital is reproduced in the original sound track’s wide dynamic range providing you with powerful sounds just like those in a movie theater. Selecting this position will be even better if you can listen to a source at a high output level in a room specially soundproofed for audio/video enjoyment.

### STD (Standard):

Powerful sounds of extremely wide dynamic range are not always suitable for home use. Depending on the condition of your listening environment, it may not be possible to increase the sound output level as high as that in a movie theater. However, at the normal level suitable for listening to in your room, the low-level parts of source sound often cannot be heard well because they will be lost among noise in your environment. Dolby Digital technology has also made it possible to reduce an original sound track’s dynamic range for a home audio format by “compressing” the sound data.

In this position, a source encoded with sound Dolby Digital is reproduced in the “compressed” dynamic range of sound that is suitable for low-level listening.

**MIN:** In this position, the dynamic range is more reduced than in the STD position.  
Selecting this position will be effective when you must listen to a source at a low level.

## C.DELAY [Adjusting the delay of center sounds (dialog, etc.)]

**Control range: 0 ms to 5 ms (in 1 ms steps)**  
**Preset value: 0 ms**

- \* This adjustment is effective only when Dolby Digital is decoded and the signals of the selected source encoded with Dolby Digital contain center-channel signals.

This adjusts the delay between the main sound (on the main channels) and dialog, etc. (on the center channel). The larger the value, the later the dialog, etc. is generated.

This is for making sounds from the left main, center and right main speakers reach your listening position at the same time. This is achieved by delaying the sound from the center speaker if the distance from the center speaker to your listening position is shorter than the distance from the left or right main speaker to your listening position.

## GUARD

**Choices: ON/OFF**  
**Preset position: OFF**

If you wish to prevent accidental alterations to SET MENU and other adjustments on this unit, select ON. The following functions on this unit can be locked by this operation:

- Functions in the SET MENU mode
- Functions in the TIME/LEVEL mode
- Functions when using TEST

## INPUT (Selecting the initial input mode of the sources connected to the TV/DBS input terminals)

**Choices: AUTO/LAST**  
**Preset position: AUTO**

You can designate the input mode that is automatically selected when the power for this unit is switched on for only the sources connected to the TV/DBS input terminals of this unit.

- AUTO:** In this position, the AUTO input mode is always selected when the power for this unit is switched on.
- LAST:** In this position, the input mode you selected last time is memorized and will not be changed when the power is switched on again.

- \* See page 30 for details on switching the input mode.

## Adjusting method

Adjustments should be made while watching the information on this unit's display.

When adjusting with the remote control transmitter, press **AMP<TUNER>** on the component selector.



Press **SET MENU** once or more so that the function which you want to change appears on the display.

### Front panel

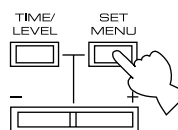

or

### Remote control

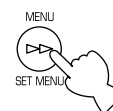

Press **+** or **-** to select any desired setting or to edit parameters of the function.

### Front panel

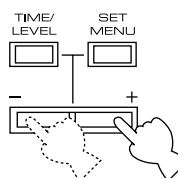

or

### Remote control

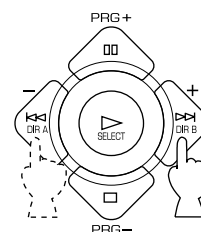

Repeat these steps to change or adjust the settings of any other function.

## Memory back-up

The memory back-up circuit prevents the stored data from being lost when this unit is set in the standby mode. If, however, the power plug is disconnected from the AC outlet or the power is cut due to temporary power failure for more than one week, the settings of the SET MENU mode will automatically return to the factory settings. If so, they can be re-set by simply following the procedure above.

# REMOTE CONTROL TRANSMITTER

You can use the remote control transmitter to control not only this unit but also other components connected to it. The remote control transmitter is factory set to control this unit and most YAMAHA audio components. To control other brands of components, you must preset the remote control transmitter with manufacturers' codes listed on pages 113 to 117.

## Components which can be controlled

There are eight buttons on the component selector that you can select to control connected components with this remote control transmitter. For example, if **CD** on the component selector is pressed, the remote control transmitter selects the CD operation mode, allowing the CD player to be operated by the buttons on the remote control transmitter.

### AMP<TUNER>

You can perform the basic operations of this unit, set the speaker level, and set the DSP level and delay time in the AMP<TUNER> mode.

### CD

The code for a YAMAHA CD player is preset.

### DVD/LD & DVD MENU

An LD player can be controlled in the DVD/LD mode. A DVD player can be controlled in the DVD/LD and DVD MENU modes. The code for a YAMAHA DVD player is preset. If the remote control transmitter will not operate your YAMAHA DVD player, you need to preset code number "0048".

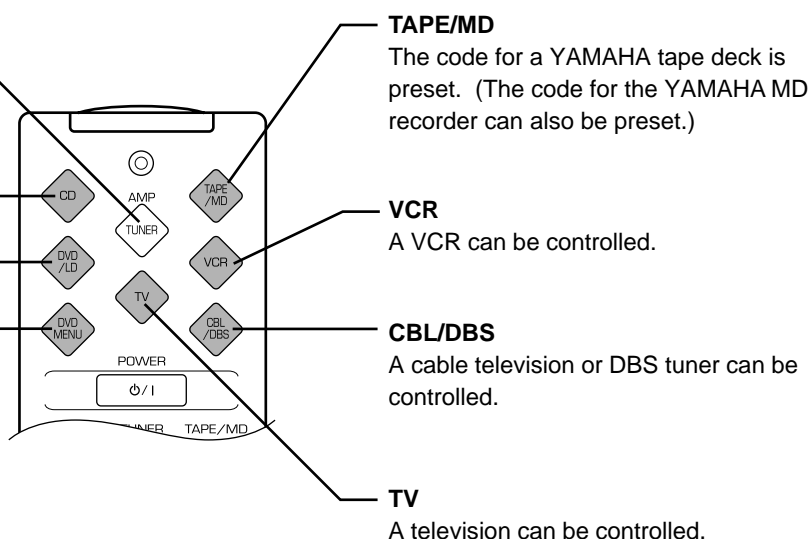

## Notes

1. You can preset the code for the manufacturer of your component after pressing the shaded buttons in the illustration above. Note that you can preset only one code for one mode. See "SETUP CODES" on page 53 for details.
2. In the DVD/LD and DVD MENU modes:
  - Be sure to press **DVD/LD** on the component selector before presetting the code for the DVD/LD player. The code preset in the DVD/LD mode is also simultaneously preset in the DVD MENU mode. You cannot preset the code for a DVD player in the DVD MENU mode.
  - DVD MENU operations cannot be performed for some DVD players.
3. When using a second (and third) VCR: (See "To use a second (and third) VCR" on page 53 for details.)
  - If you are not using a CBL/DBS (cable TV or DBS tuner), the second (or third) VCR can be preset in the CBL/DBS mode.
  - If you are not using a DVD player, the second (or third) VCR can be preset in the DVD MENU mode. Note that in this case you must preset the code for an LD player in the DVD/LD mode even if an LD player is not being used.

The lightly marked buttons do not function.

**AMP<TUNER> MODE**

**Note:** TV VOLUME and TV INPUT function if you have preset the code for your TV.

Press **AMP<TUNER>**.

**POWER**

Each time this button is pressed, the unit will switch between the power on and standby modes.

**TEST**

This button outputs a test tone for adjusting the output levels of the speakers.

**A/B/C/D/E & PRESET +/-**

These buttons select a preset FM or AM broadcast.

A/B/C/D/E: To select a group of preset stations.

PRESET +/-: To select the preset station number.

**MUTE**

This button mutes the sound. To cancel mute, press this button once more, or press any operation buttons of this unit.

**VOLUME ( ^ v )**

These buttons adjust the volume level.

**SLEEP**

This button sets the SLEEP timer.

**+/-**

These buttons adjust the settings of the SET MENU mode and the TIME/LEVEL mode.

**TIME/LEVEL**

This button selects the item in the TIME/LEVEL mode.

**Input selector**

These buttons select the program source.

CD: To play a CD

TUNER: To listen to an FM or AM broadcast

TAPE/MD: To play a tape or MD

DVD/LD: To play a DVD or LD

TV/DBS: To watch a television or satellite broadcast

VCR: To play a video tape

PHONO: To play an analog record

V-AUX: To use a camcorder

EXT. DEC.: To output the signals of a DTS or other multi-channel decoder

**EFFECT**

This button switches the DSP program on or off.

**TV VOLUME**

**TV INPUT**

**PRG+/PRG-**

These buttons select a DSP program.

**SET MENU**

This button selects functions in the SET MENU mode.

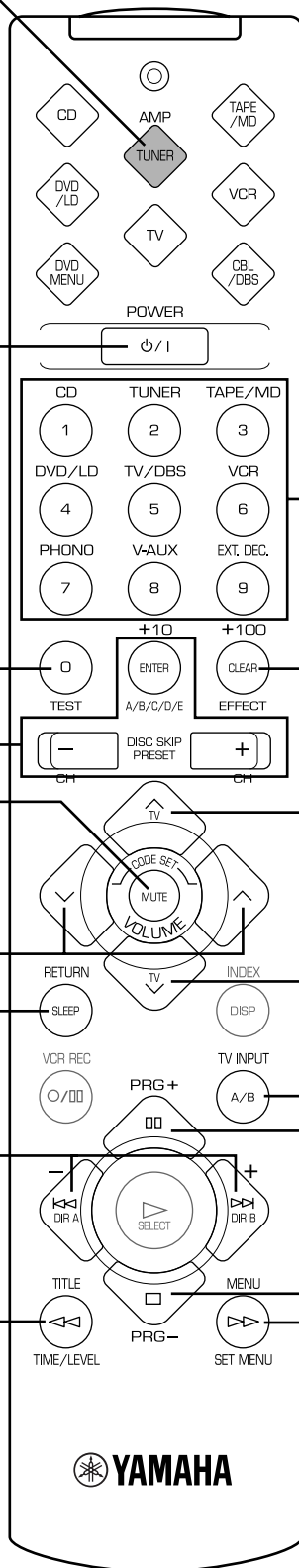

The lightly marked buttons do not function. Please refer to the owner's manual for details of each component.

## ■ TAPE/MD MODE

- Notes:**
- **TV VOLUME** functions if you have preset the code for your TV.
  - The code for the YAMAHA MD recorder can be preset.

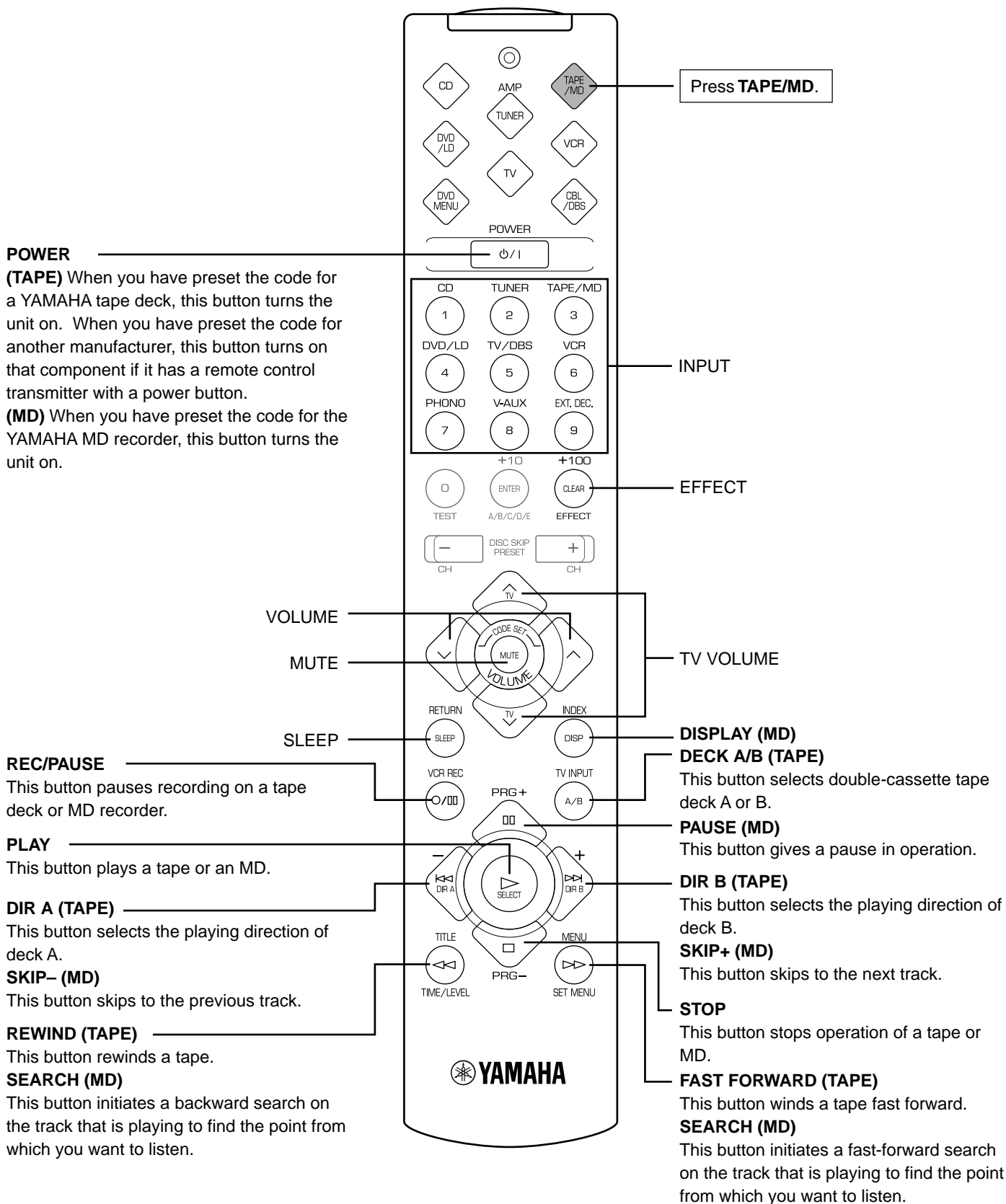



The lightly marked buttons do not function. Please refer to the owner's manual for details of each component.

■ CD MODE

Note: TV VOLUME and TV INPUT function if you have preset the code for your TV.

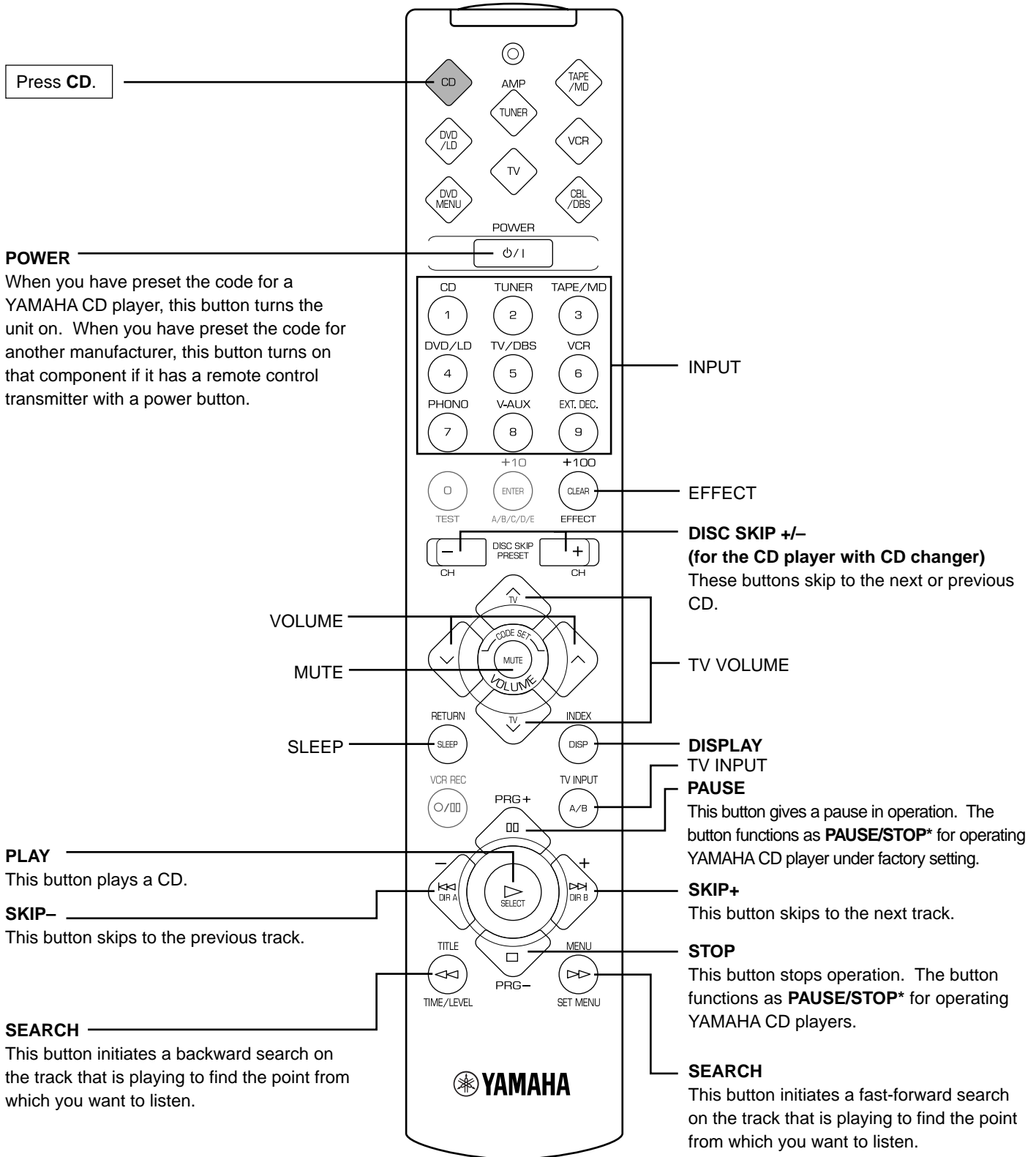

\* PAUSE/STOP function ... Press the button once to give a pause in operation and once more to stop operation.

The lightly marked buttons do not function. Please refer to the owner's manual for details of each component.

## ■ DVD/LD MODE

Press **DVD/LD**.

### POWER

**(DVD)** When you have preset the code for a YAMAHA DVD player, this button turns the unit on. When you have preset the code for another manufacturer, this button turns on that component if it has a remote control transmitter with a power button.

**(LD)** When you have preset the code for a YAMAHA LD player, this button turns the unit on. When you have preset the code for another manufacturer, this button turns on that component if it has a remote control transmitter with a power button.

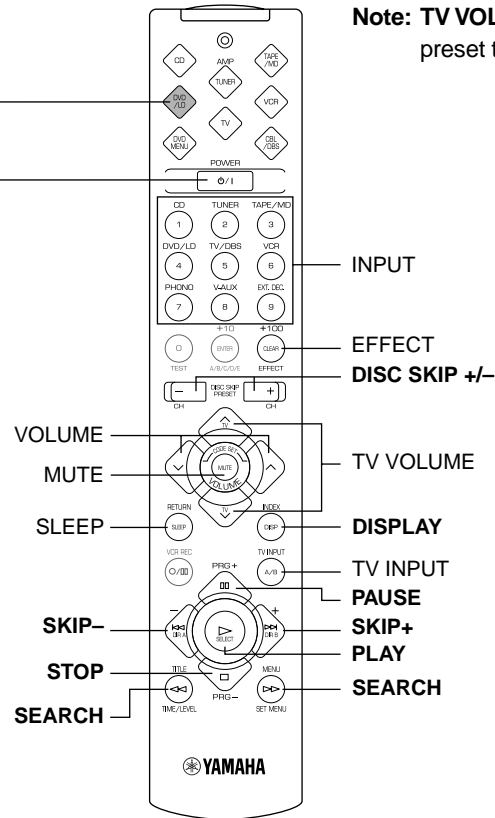

## ■ DVD MENU MODE

Press **DVD MENU**.

### POWER

When you have preset the code for a YAMAHA DVD player, this button turns the unit on. When you have preset the code for another manufacturer, this button turns on that component if it has a remote control transmitter with a power button.

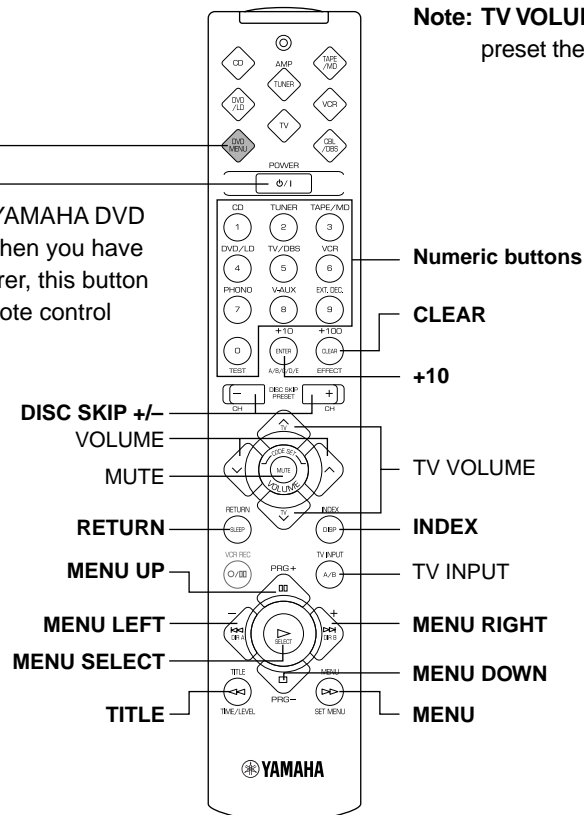

The lightly marked buttons do not function. Please refer to the owner's manual for details of each component.

### VCR MODE

**Note:** TV VOLUME, TV INPUT and TV SLEEP function if you have preset the code for your TV.

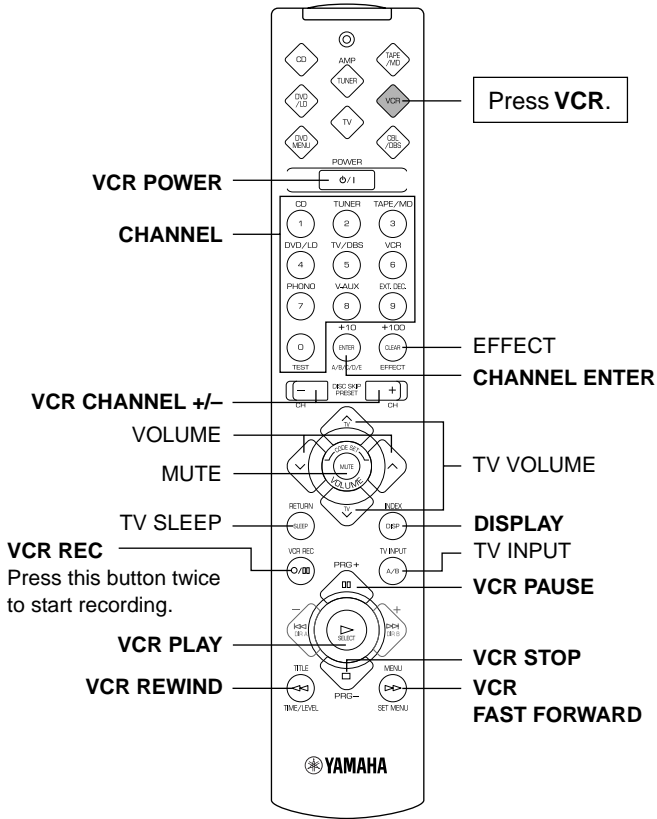

### TV MODE

**Note:** You can control your VCR if you have preset the code for it.

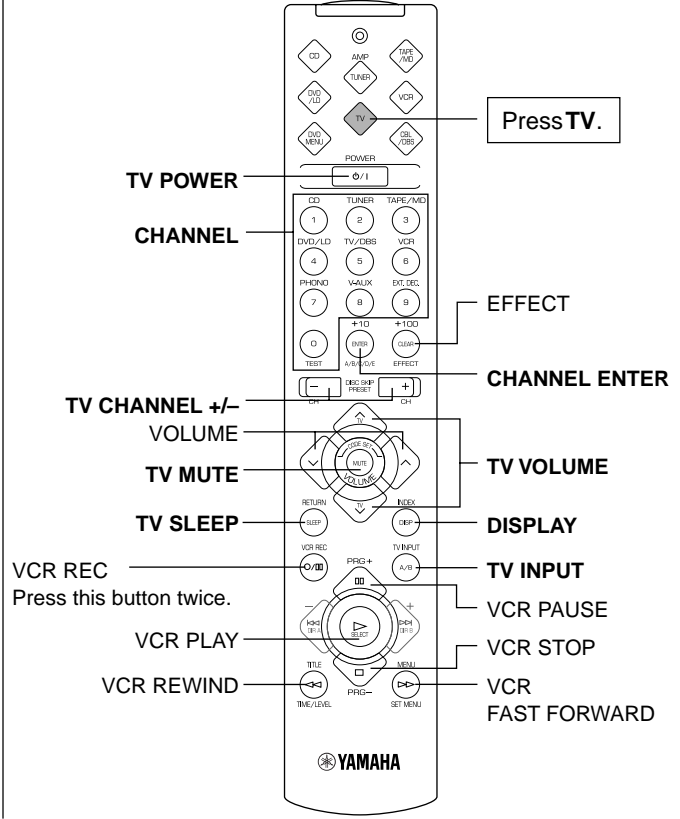

### CBL/DBS MODE

**Note:** TV VOLUME, TV INPUT and TV SLEEP function if you have preset the code for your TV.

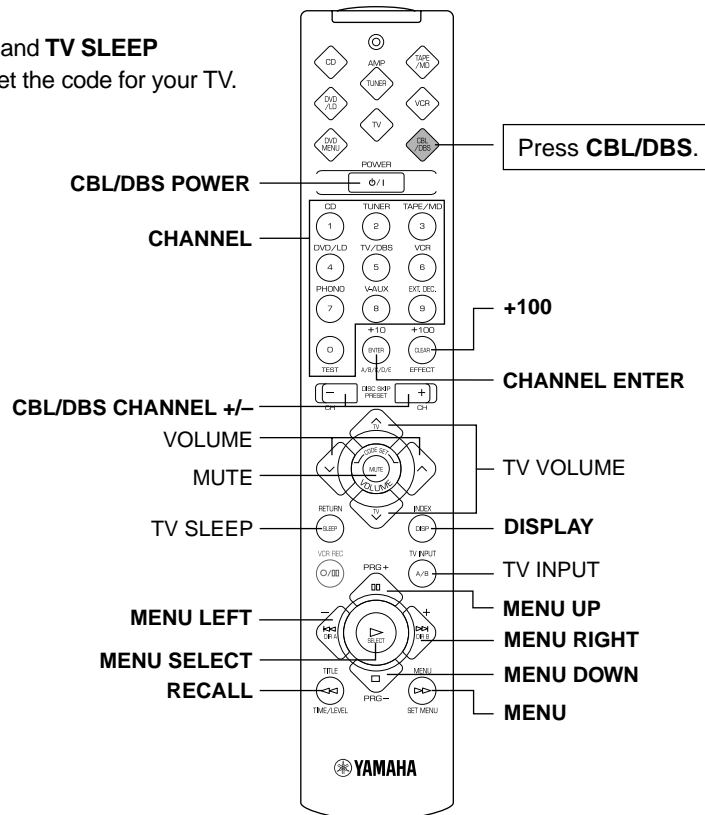

## NOTES ABOUT THE REMOTE CONTROL TRANSMITTER

### Battery installation

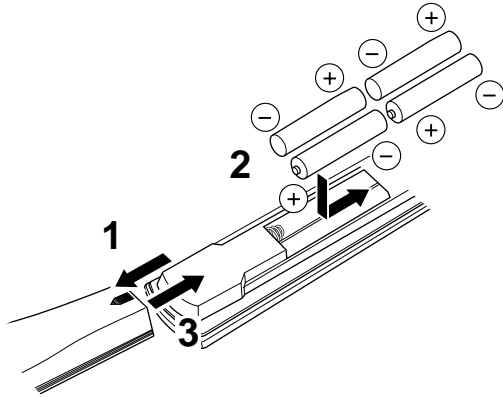

### Remote control transmitter operation range

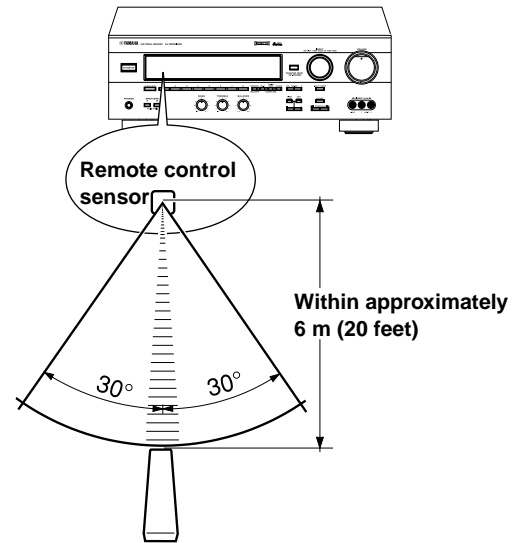

### Battery replacement

If the remote control transmitter operates only when it is close to the unit, the batteries are weak. Replace all batteries with new ones.

Be sure to replace batteries within about two minutes. If it takes longer than two minutes, the codes preset for the remote control transmitter will return to the factory-set.

#### Notes

- Use only AAA, R03, UM-4 batteries for replacement.
- Be sure the battery polarity is correct. (See the illustration inside the battery compartment.)
- Remove the batteries if the remote control transmitter will not be used for an extended period of time.
- If the batteries have leaked, dispose of them immediately. Avoid touching the leaked material or letting it come into contact with clothing, etc. Clean the battery compartment thoroughly before installing new batteries.

#### Notes

- There should be no large obstacles between the remote control transmitter and the unit.
- If the remote control sensor is directly illuminated by strong lighting (especially an inverter type of fluorescent lamp, etc.), it might cause the remote control transmitter not to work correctly. In this case, reposition the unit to avoid direct lighting.

# SETUP CODES

## Presetting the remote control transmitter

Perform the presetting procedure for each component you want to control with the remote control transmitter.

**Note:** If your component does not respond to any of the codes listed for the manufacturer, use the original remote control transmitter that was supplied with the component.

### To control your components (MD recorder, DVD player, TV, etc.)

1. Turn on the component to be used.
2. Press the component selector which matches the component to be controlled (TAPE/MD, DVD/LD, TV etc.).

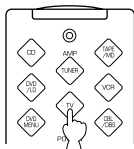

3. Press both **VOLUME** buttons (  $\wedge$   $\vee$  ) for about four seconds at the same time so that the indicator flashes twice.

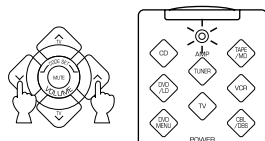

4. Use the numeric buttons to enter the four-digit manufacturer's code for the component to be used. Make sure that the indicator flashes twice. If the indicator does not flash, repeat step 3 and re-enter the code.

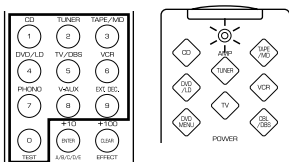

5. Press **POWER** (or any other button) on the remote control transmitter to check if you have preset the code correctly. If the component cannot be controlled by the remote control transmitter, try entering another code for the same manufacturer.

### To use a second (and third) VCR

You can control a second (and/or third) VCR in the CBL/DBS and DVD MENU modes if a CBL (or DBS) or DVD player is not being used.

If you want to control a second (and/or third) VCR in the DVD MENU mode, you must preset the code for an LD player in that mode.

1. Turn on the VCR to be used.
2. Press **CBL/DBS** or **DVD MENU** on the component selector.

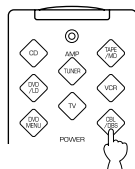

3. Press both **VOLUME** buttons (  $\wedge$   $\vee$  ) for about four seconds at the same time so that the indicator flashes twice.

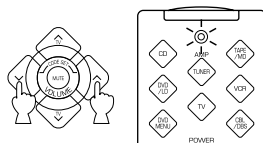

4. Use the numeric buttons to enter the four-digit code for the second (or third) VCR. Make sure that the indicator flashes twice. If the indicator does not flash, repeat step 3 and re-enter the code.

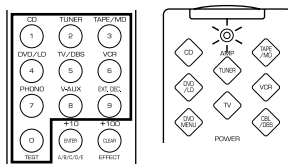

5. Press **POWER** (or any other button) on the remote control transmitter to check if you have preset the code correctly. If the VCR cannot be controlled by the remote control transmitter, try entering another code for the same manufacturer.

### Returning to the factory-set codes

To return all components to the factory-set codes, follow these steps.

1. Press a button on the component selector other than **AMP<TUNER>**.
2. Press both **VOLUME** buttons (  $\wedge$   $\vee$  ) for about four seconds at the same time so that the indicator flashes twice.
3. Enter the code number "9990".
4. Make sure that the indicator flashes twice.

To return each component to the factory-set codes, follow these steps.

1. Press the component selector which matches the component to be returned to the factory-set codes.
2. Press both **VOLUME** buttons (  $\wedge$   $\vee$  ) for about four seconds at the same time so that the indicator flashes twice.
3. Enter the code number "0000".
4. Make sure that the indicator flashes twice.

The following codes are preset by the factory.

#### Factory-set codes

Component selector	Component	Code
TV	TV	0101
CBL/DBS	DBS tuner	0006
VCR	VCR	0002
DVD/LD	DVD player	0008 YAMAHA
CD	CD player	0005 YAMAHA
TAPE/MD	Tape deck	0004 YAMAHA

We recommend that you write all code numbers you have preset on the "Quick Reference Card".

# TROUBLESHOOTING

If the unit fails to operate normally, check the following points to determine whether the fault can be corrected by the simple measures suggested. If it cannot be corrected, or if the fault is not listed in the SYMPTOM column, disconnect the power cord and contact your authorized YAMAHA dealer or service center for help.

	SYMPTOM	CAUSE	REMEDY
Amplifier	<b>The unit fails to turn on when STANDBY/ON is pressed, or set in the standby mode suddenly soon after the power has been turned on.</b>	The power cord is not plugged in or the plug is not completely inserted.	Firmly plug in the power cord.
		The <b>IMPEDANCE SELECTOR</b> switch on the rear panel is not fully set at the upper or lower end.	Slide the switch fully to the upper or lower end.
	<b>The unit does not work normally.</b>	The internal microcomputer has been frozen by an external electric shock (lightning, excessive static electricity, etc.) or by a power supply with low voltage.	Set the unit in the standby mode and disconnect the AC power cord from the AC outlet. After about 30 seconds have passed, connect the power cord and operate the unit again.
	<b>No sound or no picture.</b>	Incorrect output cord connections.	Connect the cords properly. If the problem persists, the cords may be defective.
		Appropriate program source has not been selected.	Select an appropriate program source by <b>INPUT</b> .
		<b>SPEAKERS</b> have not been set properly.	Set <b>SPEAKERS</b> corresponding to the speakers in use to the ON position.
		The speaker connections are not secure.	Secure the connections.
	<b>The sound suddenly goes off.</b>	The protection circuit has been activated because of a short circuit, etc.	Set the unit in the standby mode and then switch on again to reset the protection circuit.
		The SLEEP timer has functioned.	Cancel the SLEEP timer.
	<b>Only one side speaker outputs sound.</b>	Incorrect setting of <b>BALANCE</b> .	Adjust it to the appropriate position.
		Incorrect cord connections.	Connect the cords properly. If the problem persists, the cords may be defective.
	<b>A "humming" sound can be heard.</b>	Incorrect cord connections.	Firmly connect the audio plugs. If the problem persists, the cords may be defective.
		No connection from the turntable to the <b>GND</b> terminal.	Make the GND connection between the turntable and this unit.
	<b>The volume level is low while playing a record.</b>	The record is being played on a turntable with an MC cartridge.	The turntable should be connected to the unit through the MC head amplifier.
	<b>The volume level cannot be increased, or the sound is distorted.</b>	The component connected to the <b>REC OUT</b> terminals of this unit is in the standby mode.	Turn on the power to the component.
	<b>No sound from the effect speakers.</b>	The sound effect is set off.	Press <b>EFFECT</b> to turn it on.
		A Dolby Surround decoding program is being used with material not encoded with Dolby Surround.	Use a different sound field program.
	<b>No sound from the rear speakers.</b>	The sound output level of the rear speakers is set to minimum.	Raise the sound output level of the rear speakers.
A monaural sound source is being played in the <b>DOLBY PRO LOGIC</b> or <b>DOLBY PRO LOGIC ENHANCED</b> program.		Select another sound field program suitable for the monaural sound source.	

	SYMPTOM	CAUSE	REMEDY
Amplifier	<b>No sound from the center speaker.</b>	The input signals of the source encoded with Dolby Digital do not have center channel signals.	Refer to the instruction for the source being currently played.
		The sound output level of the center speaker is set to minimum.	Raise the sound output level of the center speaker.
		The function "CNTR" in the SET MENU is set to the NONE position.	Select the LARGE or SMALL position.
		Incorrect sound field program selection.	Select the appropriate program.
	<b>The sound field cannot be recorded.</b>	It is not possible to record the sound field on a tape deck or MD recorder connected to the unit's <b>REC OUT</b> terminals.	/
	<b>The DVD/LD, TV or DBS source cannot be recorded on a tape deck, MD recorder or VCR connected to this unit.</b>	The DVD/LD player, TV or DBS tuner is connected to the unit by only the digital terminals.	Make additional connections between the analog terminals.
FM	<b>FM stereo reception is noisy.</b>	The characteristics of FM stereo broadcasts may cause this problem when the transmitter is too far away or the antenna input is poor.	Check the antenna connections. Try using a high-quality directional FM antenna. Set <b>TUNING MODE</b> to the manual tuning mode.
	<b>There is distortion and clear reception cannot be obtained even with a good FM antenna.</b>	There is multipath interference.	Adjust antenna position to eliminate multipath interference.
	<b>The desired station cannot be tuned in with the automatic tuning method.</b>	The station is too weak.	Use the manual tuning method. Use a high-quality directional FM antenna.
	<b>Previously preset stations can no longer be tuned in.</b>	This unit has been unplugged for a long period.	Repeat the presetting procedure.
AM	<b>The desired station cannot be tuned in with the automatic tuning method.</b>	The signal is weak or antenna connections are loose.	Tighten the AM loop antenna connections and rotate it for best reception. Use the manual tuning method.
	<b>There are continuous crackling and hissing noises.</b>	Noise will result from lightning, fluorescent lamps, motors, thermostats and other electrical equipment.	Use an outdoor antenna and a ground wire. This will help somewhat, but it is difficult to eliminate all noise.
	<b>There are buzzing and whining noises (especially in the evening).</b>	A television set is being used nearby.	Relocate this unit away from the TV.
FM/AM	<b>&lt;China and General models only&gt; Although you do the operations to recall a preset station, the station cannot be tuned in, or a station other than the preset one is tuned in.</b>	Some of the preset station data has been modified because the setting of the FREQUENCY STEP switch was changed after storing the station data.	Preset the stations again by following the preset tuning procedure.
Remote control transmitter	<b>The remote control transmitter does not work.</b>	Direct sunlight or lighting (from an inverter type of fluorescent lamp, etc.) is striking the remote control sensor of the this unit.	Change the position of the unit.
		The manufacturer's code has not been set properly.	Set the code again.
		The proper manufacturer's code for the component to be controlled has not been set.	Try entering another code for the same manufacturer.
		The component to be controlled has not been selected.	Press the component selector which matches the component to be controlled.

	<b>SYMPTOM</b>	<b>CAUSE</b>	<b>REMEDY</b>
<b>Others</b>	<b>The sound is degraded when listening with the headphones to a CD player or tape deck that is connected to this unit.</b>	The unit is in the standby mode.	Turn on the power to the unit.
	<b>There is noise interference from digital or high-frequency equipment or the unit.</b>	The unit is too close to the digital or high-frequency equipment.	Move the unit further away from those equipment.



# SPECIFICATIONS

## AUDIO SECTION

### Minimum RMS Output Power

8 ohms, 20 Hz to 20 kHz, 0.04% THD	
MAIN L/R .....	60 W + 60 W
CENTER .....	60 W
REAR L/R .....	60 W + 60 W
8 ohms, 1 kHz, 0.07% THD	
MAIN L/R .....	70 W + 70 W
CENTER .....	70 W
REAR L/R .....	70 W + 70 W

### Maximum Power

[China and General models only]

8 ohms, 1 kHz, 10% THD	
MAIN L/R .....	95 W + 95 W
CENTER .....	95 W
REAR L/R .....	95 W + 95 W

### Dynamic Power per Channel

(by IHF Dynamic Headroom measuring method)

MAIN L/R	
8/6/4/2 ohms .....	80/100/120/145 W

### Dynamic Headroom (8 ohms)

[U.S.A. and Canada models only]

.....	1.55 dB
-------	---------

### Power Band Width

8 ohms, 30 W, 0.1% THD	
.....	10 Hz to 50 kHz

### Damping Factor

MAIN L/R	
8 ohms, 20 Hz to 20 kHz .....	60 or more

### Input Sensitivity/Impedance

PHONO MM .....	2.5 mV/47 k-ohms
CD/TAPE-MD/DVD-LD/TV-DBS/VCR/ VIDEO AUX .....	150 mV/47 k-ohms
EXT. DECODER	
MAIN L/R .....	150 mV/47 k-ohms
CENTER/SURROUND L/R/SUBWOOFER .....	150 mV/40 k-ohms

### Maximum Input Signal

PHONO MM	
1 kHz, 0.1% THD .....	100 mV or more
CD/TAPE-MD/DVD-LD/TV-DBS/VCR/ VIDEO AUX (EFFECT ON)	
1 kHz, 0.5% THD .....	2.2 V or more

### Output Level/Impedance

REC OUT .....	150 mV/1.2 k-ohms
SUBWOOFER (MAIN SP: SMALL) .....	4.0 V/1.2 k-ohms

### Headphones Jack Rated Output/Impedance

CD/TAPE-MD/DVD-LD/TV-DBS/VCR/ VIDEO AUX input, 1 kHz, 150 mV, 8 ohms .....	0.4 V/390 ohms
--	----------------

### Frequency Response (20 Hz to 20 kHz)

CD/TAPE-MD/DVD-LD/TV-DBS/VCR/ VIDEO AUX to MAIN L/R SP OUT .....	0±0.5 dB
--	----------

### RIAA Equalization Deviation

PHONO MM .....	0±0.5 dB
----------------	----------

### Total Harmonic Distortion (20 Hz to 20 kHz)

PHONO MM to REC OUT 1 V .....	0.02% or less
CD/TAPE-MD/DVD-LD/TV-DBS/VCR/ VIDEO AUX (EFFECT OFF) to MAIN SP OUT	
30 W/8 ohms .....	0.025% or less

### Signal-to-Noise Ratio (IHF-A Network)

PHONO MM to REC OUT [U.S.A., Canada, China and General models]	
(5 mV, Input Shorted) .....	86 dB or more
[Australia and Singapore models] (5 mV, Input Shorted) .....	81 dB or more
CD/TAPE-MD/DVD-LD/TV-DBS/VCR/ VIDEO AUX (EFFECT OFF) to MAIN SP OUT	
(150 mV, Input Shorted) .....	96 dB or more

### Residual Noise (IHF-A Network)

MAIN L/R SP OUT .....	150 µV or less
-----------------------	----------------

### Channel Separation

(Vol. -30 dB, EFFECT OFF)	
PHONO MM (Input Shorted, 1 kHz/10 kHz) .....	60 dB or more/55 dB or more
CD/TAPE-MD/DVD-LD/TV-DBS/VCR/ VIDEO AUX (Input 5.1 k-ohms Terminated, 1 kHz/10 kHz) .....	60 dB or more/45 dB or more

### Tone Control Characteristics

BASS: Boost/cut .....	±10 dB (50 Hz)
Turnover Frequency .....	350 Hz
TREBLE: Boost/cut .....	±10 dB (20 kHz)
Turnover Frequency .....	3.5 kHz

### Filter Characteristics

MAIN L/R, REAR L/R (SPEAKER: SMALL) (H.P.F) .....	fc = 90 Hz, 12 dB/oct.
SUBWOOFER (L.P.F) .....	fc = 90 Hz, 18 dB/oct.

## VIDEO SECTION

### Video Signal Type

[U.S.A. and Canada models] .....	NTSC
[Australia and Singapore models] .....	PAL
[China and General models] .....	NTSC/PAL

Video Signal Level ..... 1 Vp-p/75 ohms

Maximum Input Level ..... 1.5 Vp-p or more

Signal-to-Noise Ratio ..... 50 dB or more

### Monitor Output Frequency Response

.....	5 Hz to 10 MHz, -3 dB
-------	-----------------------

## FM SECTION

### Tuning Range

[U.S.A. and Canada models] .....	87.5 to 107.9 MHz
[Australia and Singapore models] .....	87.50 to 108.00 MHz
[China and General models] 100 kHz step .....	87.5 to 108.0 MHz
50 kHz step .....	87.50 to 108.00 MHz

### 50 dB Quieting Sensitivity (IHF)

(100% mod., 1 kHz)	
Mono .....	1.6 µV (15.3 dBf)
Stereo .....	23 µV (38.5 dBf)

### Usable Sensitivity (DIN)

[Australia and Singapore models only] Mono (S/N 26 dB) .....	0.9 µV
Stereo (S/N 46 dB) .....	28 µV

### Alternate Channel Selectivity (±400 kHz)

[U.S.A., Canada, China and General models only] .....	75 dB
--	-------

### Selectivity

(two signals, 40 kHz Dev. ±300 kHz) [Australia and Singapore models only] .....	55 dB
---	-------

Signal-to-Noise Ratio  
 (IHF) Mono/Stereo  
 [U.S.A., Canada, China and General models] ..... 81 dB/75 dB  
 (DIN-Weighted, 40 kHz Dev.) Mono/Stereo  
 [Australia and Singapore models] ..... 75 dB/69 dB

Harmonic Distortion (1 kHz)  
 Mono/Stereo ..... 0.1%/0.2%

Stereo Separation (1 kHz) ..... 48 dB

Frequency Response  
 20 Hz to 15 kHz ..... 0±1 dB

Antenna Input ..... 75 ohms, Unbalanced

Output Level  
 [U.S.A., Canada, China and General models]  
 (100% mod., 1 kHz) ..... 550 mV  
 [Australia and Singapore models]  
 (40 kHz Dev., 1 kHz)] ..... 550 mV

**AM SECTION**

Tuning Range  
 [U.S.A. and Canada models] ..... 530 to 1,710 kHz  
 [Australia and Singapore models] ..... 531 to 1,611 kHz  
 [China and General models]  
 10 kHz step ..... 530 to 1,710 kHz  
 9 kHz step ..... 531 to 1,611 kHz

Usable Sensitivity ..... 300 µV/m

Signal-to-Noise Ratio ..... 52 dB

Antenna ..... Loop antenna

Output Level  
 (30% mod., 1 kHz) ..... 150 mV

**GENERAL**

Power Supply  
 [U.S.A. and Canada models] ..... AC 120 V, 60 Hz  
 [Australia model] ..... AC 240 V, 50 Hz  
 [General model] ..... AC 110/120/220/240 V, 50/60 Hz  
 [China model] ..... AC 220 V, 50 Hz  
 [Singapore model] ..... AC 230 V, 50 Hz

Power Consumption  
 [U.S.A., Australia, Singapore, China and General models] ..... 230 W  
 [Canada model] ..... 260 W/340 VA

Maximum Power Consumption  
 5 ch, 10% THD  
 [General model only] ..... 630 W

AC Outlets  
 2 SWITCHED OUTLETS  
 [U.S.A., Canada, Singapore, China and General models] ..... 100 W max. total  
 1 SWITCHED OUTLET  
 [Australia model] ..... 100 W max.

Dimensions (W x H x D)  
 ..... 435 x 151 x 391 mm  
 (17-1/8" x 5-15/16" x 15-3/8")

Weight  
 ..... 11.2 kg (24 lbs. 11 oz.)

Accessories ..... AM loop antenna  
 Indoor FM antenna  
 Remote control transmitter  
 Batteries  
 Antenna adapter  
 (U.S.A. and Canada models only)

Specifications are subject to change without notice.

**LIST OF MANUFACTURER'S CODES  
LISTES DES CODES FABRICANT**

**TV**

A-Mark	1161	Dansai	1001	Ima	1051
A Tandy	0941	Daytron	0941, 1031	Indiana	1001
Abex	1151	Decca	0271, 1001	Infinity Reference	0101
Admira	1141	Dixi	0331, 1001, 1071	Interfunk	1001
Adventura	1131	Dumont	0891, 1031	ITT	0611
Aiko	1121	Dynatech	0881	Janeil	1131
Akai	0331, 1101, 1111	Electroband	0951, 1011	JBL	0101
Alba	0431	Electrohome	0941	JCB	0951
Alleron	1091	Electron	0941	Jensen	0311
Ambassador	1081	Elin	1001	Jinxiing	1531, 1541, 1551, 1561, 1571, 1621, 1631, 1641, 1651, 1691, 1731
Amstrad	0481, 1081	Elta	0331	JVC	0261, 0281, 0641, 0651, 0661, 0841
Anam	0251, 1041, 1051, 1061, 1071	Emerson	0001, 0021, 0061, 0071, 0081, 0091, 0111, 0811, 0821, 0831, 0841, 0851, 0861, 0871, 0901, 0921, 0941, 0981, 1011, 1031, 1051, 1081, 1091	Kawasho	0901
Anam National	1041	Envision	0361, 1111	Kaypani	1021
AOC	0361, 1021, 1031, 1111, 1161	Erres	1001	Kenwood	0361, 1031, 1111
Archer	1161	Etron	0331	Kloss	0631, 0721, 1131
Audiosonic	1001	Ferguson	1001	KTV	0921, 0941, 1011, 1051, 1111
Audiovox	1051, 1161	Finlux	1001	Leyco	1001
Awai	1481	Fisher	0171, 0801, 0981	Liesenk & Tter	1001
Bauer	0441	Formenti	0441	Lloytron	0941
Baur	1001	Formonti	1001	Loewe	1001
Beijing	1511, 1551, 1561	Fortress	1141	Logik	0991, 1771
Belcor	1031	Fujitsu	1091	Luxman	0351, 0971
Bell & Howell	0981, 0991	Funai	1051, 1091, 1341, 1361, 1411, 1451, 1501, 1521	Lxi	0101, 0621, 0761, 0861, 0981
Beon	1001	Futuretech	1051	Magnavox	0101, 0341, 0391, 0401, 0411, 0421, 0581, 0591, 0601, 0611, 0631, 0661, 0961, 1111
Bradford	1051	GE	0131, 0161, 0201, 0751, 0761, 0771, 0781, 0791, 0811, 0861, 1041	Majestic	0991
Brockwood	1031	GEC	0271, 1001	Marantz	0101, 0221, 0361, 1001, 1111
Broksonic	1161	Gemini	0391	Mark	1001
Bush	1001	Genexxa	0431	Matsui	0271, 0331, 1001
Candle	0351, 0361, 0961, 0971, 1111, 1131	Gibraltar	0891, 1031, 1111	Mediator	1001
Capehart	1021	GoldStar	0031, 0121, 0351, 0411, 0731, 0741, 0861, 0941, 0971, 1001, 1031, 1111, 1151	Megatron	0691, 0861, 1161
Carver	0101	Goodmans/Tashiko	0271, 0661, 1001	MEI	1011
Cathay	1001	Granada	1001	M Electronic	1001
Celebrity	0951	Grundig	1781, 1791, 1801, 1811, 1821, 1831, 1841, 1851, 1861, 1871, 1881	Memorex	0331, 0571, 0861, 0971, 0981, 0991, 1771
Centurion	0411	Gunpy	1051, 1091	Metz	1791, 1831, 1891, 1901, 1911, 1921, 1931, 1941
Changhong	1541, 1551, 1561, 1621	H/K	0721	MGA	0361, 0561, 0571, 0861, 1031, 1111
Citizen	0351, 0361, 0921, 0931, 0941, 0961, 0971, 1111, 1121, 1131	Hallmark	0861	Midland	0751, 0761, 0891, 0941, 1151
Clairtone	1011	Hanseatic	1001	Mitsubishi	0221, 0321, 0561, 0571, 0661, 0861, 1031, 1101, 1381
Clarivox	1001	Harvard	1051, 1061	Montgomery	1091
Concerto	0351, 0971	Hinari	1001, 1091	Motorola	1041, 1141
Conrowa	1751	Hitachi	0181, 0351, 0671, 0681, 0691, 0701, 0711, 0871, 0941, 0971, 1351	MTC	0351, 0361, 0881, 0931, 0971, 1011, 1031, 1111
Contec	0901, 0911, 1011, 1051	Hypson	1001	Multitech	0881, 1051
Corando	0941			NAD	0551, 0621, 0861
Craig	0251, 1051			NEC	0241, 0351, 0361, 0661, 0971, 1031, 1111, 1321, 1711
Crown	0941, 1051				
Curtis Mathes	0161, 0361, 0931, 0941, 0981, 1111				
CXC	1051				
Daewoo	0291, 0301, 0331, 0721, 0941, 1001, 1031, 1121, 1191, 1531, 1581, 1591, 1601				

Neckermann	1001	SBR	1001	Video Concept	1101
Nei	1001	Schneider	1001	Vidikron	0101, 0211
Nikkai	0271, 0431, 1001, 1151	Scimitsu	1031	Vidtech	0861, 1031
Nikko	0861, 1111, 1121	Scotch	0861	Viking	1131
Novabeam	0721	Scott	0831, 0861, 0941, 1031, 1051, 1091	Wards	0101, 0361, 0451, 0541, 0581, 0591, 0601, 0611, 0771, 0781, 0791, 0861, 0971, 0991, 1031, 1091, 1111, 1771
NTC	1121	Sears	0101, 0161, 0171, 0351, 0481, 0521, 0621, 0761, 0801, 0861, 0971, 0981, 1091	Watson	1001
Onwa	1051	Shanghai	1561, 1681	Xogego	1611, 1621, 1661, 1741, 1761
Optimus	0551	Sharp	0461, 0471, 0541, 0661, 0911, 0941, 1141, 1241, 1271	Yamaha	0221, 0361, 0571, 1031, 1111, 1141, 1381
Optonica	0541, 1141	Shogun	1031	Yoko	1001
Orion	0831, 1001	Signature	0991, 1771	Zenith	0011, 0041, 0891, 0991, 1771
Osaki	0271, 1151	Simpson	0581, 0961	Zonda	1161
Otto Versand	1001	Solavox	1151		
Panasonic	0101, 0191, 0251, 0751, 1041, 1311, 1371, 1431	Sonoko	1001		
Panda	1541, 1721	Sontec	1001		
Penny	0161, 0361, 0521, 0531, 0621, 0731, 0751, 0761, 0781, 0791, 0861, 0931, 0941, 1031, 1041, 1111, 1151, 1161	Sony	0371, 0451, 0661, 0841, 0951, 1281, 1441		
Peony	1561, 1621	Soundesign	0861, 0961, 1051, 1091		
Philco	0361, 0581, 0591, 0601, 0611, 0631, 0961, 1031, 1111	Soundwave	1001		
Philips	0101, 0401, 1001	Spectricon	1161		
Phonola	1001	Squareview	0481		
Pilot	0941, 1031, 1111	SSS	1031, 1051		
Pioneer	0511, 0551, 0871, 1331	Star-lite	1051		
Portland	0941, 1031, 1121	Suprem	0951		
Priceclub	0931	Supre-macy	1131		
Prism	0751	Surpa	0351, 0971		
Proscan	0761	Sylvania	0101, 0361, 0441, 0581, 0591, 0601, 0611, 0631, 0961, 1111		
Protech	1001	Symphonic	0481		
Proton	0501, 0861, 0941, 1021, 1161	Sysline	1001		
Pulsar	0891	Tandy	0271, 0431, 1141		
Pulser	1031	Tatung	0271, 0881, 1001, 1041, 1161		
Quasar	0251, 0751, 1041	Tcl	1561, 1631, 1701		
Quelle	1001	Technics	0751		
Radio Shack	0541, 0941, 1031, 1051, 1151	Techwood	0351, 0751, 0971		
Radiola	1001	Teknika	0101, 0351, 0571, 0931, 0941, 0961, 0971, 0991, 1031, 1051, 1091, 1121, 1131, 1771		
RCA	0051, 0141, 0151, 0181, 0411, 0491, 0531, 0761, 0771, 0871, 1031	Teletech	0331		
Realistic	0541, 0861, 0941, 0971, 0981, 1031, 1051, 1111, 1151	Tera	0501		
Rhapsody	1011	Thakral	1671		
R-line	1001	Thorm	1001		
Runco	0891, 1111	TMK	0351, 0861, 0971, 1081		
Saisho	0331, 1081	Toshiba	0381, 0521, 0621, 0661, 0931, 0981, 1301		
Sampo	0361, 0941, 1021, 1111, 1151	Tosonic	1011		
Samsung	0331, 0341, 0351, 0361, 0861, 0931, 0941, 0971, 1001, 1031, 1111, 1151, 1461	Totevision	0941		
Samsux	0941	Trical	0911		
Sanyo	0171, 0231, 0271, 0661, 0801, 0911, 0981, 1231, 1251, 1261	Universal	0781, 0791		
		Universum	1001		
		Vector Research	0361, 1111		
		Vestel	1001		
		Victor	0651, 1201, 1211, 1221		

---

## CABLE

ABC	0256, 0376
Antronix	0136
Archer	0136, 0286
BBT	0076
Cabletime	0166
Cablevision	0196
Colour Voice	0306, 0346
Comtronics	0216, 0276
Eagle Comronics	0276
Eastern	0066
Electricord	0206
Electus	0266
GE	0116, 0126
GEC Cable System	0196
Hamlin H5	0676
Hamlin H6	0666
Hamlin H6S	0656
Hamlin H8	0646
Hamlin H9	0636
Jerrold	0256
Jerrold 400L	0626
Jerrold 450L	0616
Jerrold 550	0606
Jerrold Osd Catv	0596
Jerrold Sprucer	0436
Magnavox/Philips	0416, 0426
Mamm	0296
Memorex	0386
Movie Time	0146, 0206
Northcoast	0016
NSC	0146
Oak	0106
Oak Sigma 450	0546
Oak Sigma 550	0536
Panasonic TZ 120/130	0476
Panasonic TZ 170/180	0446
Panasonic TZ140	0466
Panasonic TZ150/160	0456
Paragon	0386

Philips 0036, 0216, 0306, 0316,  
0326, 0336, 0346  
Pioneer 0006, 0086  
Pioneer BR50 0846  
Pioneer BR60/70/80/81/82 0696  
Pioneer BR90 0556  
Pulsar 0386  
RCA Digital Satellite System 0396, 0406  
Realistic 0136  
Regency/Eastern 0686  
Runco 0386  
Samsung 0276  
Scientific Atlanta 175/475 0576  
Scientific Atlanta 75 0366, 0586  
Scientific Atlanta 8650 0566  
Signal 0276  
SL Marx 0276  
Spectavision 0236  
Standard Components 0186  
Starcom V 0256  
Stargate 0276  
Sylvania/Texscan 0376, 0496  
Teknika 0176  
Teleservice 0056  
Televue 0276  
Texscan 0186, 0376  
TFC 0026  
Tocom 0226, 0356  
Tocom 5503A 0526  
Tocom 5503VIP/5507 0516  
Tocom TC56 0506  
Toshiba 0386  
Tudi 0046  
Unika 0136  
Universal 0136, 0156, 0206, 0286  
Videoway 0096  
Viewstar 0216  
Zenith 0246, 0386, 0486

## DBS TUNER

Alpha Star 0826  
Chaparral 0756  
Echostar 0836  
General Instrument 0776  
HTS 0836  
Hughes Network Systems 0816  
Jerrold 0776, 0786  
Panasonic 0806  
Primestar 0776, 0786  
RCA 0766  
Sony 0796

## VCR

A Tandy 0902  
Adventura 0992  
Aiko 0982  
Aiwa 0992  
Akai 0262, 0942, 0952, 0962, 0972  
American High 0932  
Amstrad 0992  
ASA 0002, 0912  
Asha 0922  
Audio Dynamics 0202  
Audiovox 0912  
Beaumarck 0922  
Bell & Howell 0902  
Blaupunkt 0412  
Broksonic 0872, 0882, 0892  
Bush 0852  
Calix 0912  
Canon 0862, 0932  
CCE 0852, 0982  
Citizen 0912, 0982  
Colt 0852  
Craig 0832, 0842, 0852, 0912, 0922  
Curtis Mathes 0662, 0822, 0932  
Cybernex 0922  
Daewoo 0802, 0812, 0982  
DBX 0202  
Dynatech 0472, 0992  
Electrohome 0912  
Electroponic 0912  
Emerex 0792  
Emerson 0072, 0132, 0142, 0152,  
0162, 0172, 0182, 0192,  
0212, 0702, 0712, 0722,  
0732, 0742, 0752, 0762,  
0772, 0782, 0872, 0882,  
0892, 0912, 0952,  
0992, 1072  
Finlux 0002, 0992  
Fisher 0682, 0692, 0842, 0902  
Fuji 0672, 0932  
Funai 0992  
Garrard 0992  
GE 0662, 0822, 0932  
Go Video 0642, 0652  
GoldStar 0082, 0632, 0912  
Goodmans 0402  
Gradiente 0992  
Granda 0612, 0902  
Grundig 0002  
H/K 1082  
Harley Davidson 0992  
Harmon/Kardon 0632, 1082  
Harwood 0752, 0852  
Headquarter 0612  
HI-Q 0842

Hinari 0852  
Hitachi 0102, 0562, 0572, 0582,  
0592, 0602, 0992  
ITT 0942  
JVC 0202, 0522, 0532, 0542, 0552  
Kenwood 0202, 0542, 0612,  
0632, 0902  
KLH 0852  
Kodak 0912, 0932  
Lloyd 0992  
Logik 0852  
Luxor 0942  
LXI 0022, 0912  
Magnavox 0002, 0482, 0492,  
0502, 0512, 0932  
Magnin 0922  
Marantz 0002, 0202, 0402, 0632, 0932  
Marta 0912  
Matsui 0722  
Matsushita 0932  
MEI 0222, 0932  
Memorex 0232, 0242, 0472, 0512,  
0612, 0842, 0902, 0912,  
0922, 0932, 0992  
MGA 0762, 0952  
MGA Technology 0922  
Minolta 0592, 0602  
Mitsubishi 0452, 0462, 0542,  
0762, 0952, 1082  
Motorola 0472, 0932  
MTC 0922, 0992  
Multitech 0852, 0992  
NAD 0442  
NEC 0122, 0202, 0292, 0422,  
0432, 0542, 0632  
Nikko 0912  
Noblex 0922  
Olympus 0412, 0932  
Optimus 0442, 0472, 0912  
Optonica 0402  
Orion 0212, 0722, 0742, 0772  
Osaki 0912  
Panasonic 0012, 0052, 0092,  
0222, 0372, 0382,  
0392, 0412, 0932  
Penny 0202, 0432, 0602, 0632,  
0692, 0912, 0922, 0932  
Pentax 0592, 0602  
Perdio 0992  
Philco 0002, 0932  
Philips 0002, 0282, 0402, 0492, 0932  
Pilot 0912  
Pioneer 0442, 0542  
Proscan 1002, 1012, 1022, 1032,  
1042, 1052, 1062  
Pulsar 0512  
Quarter 0612

Quartz 0272, 0612  
 Quasar 0382, 0392, 0932  
 Radio Shack 0912, 0992  
 Radix 0912  
 Randex 0912  
 RCA 0112, 0382, 0392, 0482, 0592,  
 0602, 0662, 0822, 0942  
 Realistic 0402, 0472, 0612, 0682,  
 0842, 0902, 0912,  
 0922, 0932, 0992  
 Ricoh 0352, 0362  
 Saisho 0212, 0582, 0722,  
 0732, 0742, 0772  
 Salora 0612, 0762  
 Samsung 0212, 0312, 0922, 0962  
 Sanky 0472, 0512  
 Sansui 0292, 0542, 0832  
 Sanyo 0242, 0612, 0842, 0902, 0922  
 SBR 0002, 0282  
 Schneider 0852  
 Scott 0342, 0712, 0762,  
 0872, 0882, 0892  
 Sears 0302, 0592, 0602, 0612,  
 0682, 0692, 0842,  
 0902, 0912, 0932  
 Sharp 0402, 0472  
 Shintom 0852  
 Shogun 0922  
 Singer 0852  
 Sony 0032, 0332, 0352, 0362,  
 0672, 0792, 0932  
 STS 0602  
 Sunpak 0352  
 Sylvania 0002, 0492, 0502,  
 0762, 0932, 0992  
 Symphonic 0992  
 Tandy 0992  
 Tashiko 0712, 0992  
 Teac 0992  
 Technics 0932  
 Teknika 0322, 0912, 0932, 0992  
 Telefunken 0252  
 TMK 0212, 0732, 0772, 0922  
 Toshiba 0062, 0302, 0342, 0622,  
 0682, 0712, 0762  
 Totevision 0912, 0922  
 Unitech 0922  
 Vector Research 0202, 0432, 0632  
 Victor 0532, 0542, 0552  
 Video Concepts 0202, 0432,  
 0632, 0952  
 Wards 0322, 0402, 0472, 0482,  
 0602, 0712, 0842, 0852,  
 0922, 0932, 0992  
 Yamaha 0202, 0632, 0762  
 Zenith 0042, 0362, 0512, 0672

## DVD PLAYER

Akai 0108  
 JVC 0168  
 Onkyo 0128  
 Panasonic 0048  
 Philips 0188  
 Pioneer 0208, 0228  
 Samsung 0148  
 Sharp 0068  
 Sony 0028  
 Toshiba 0088  
 Yamaha 0008, 0048

## LD PLAYER

Aiwa 0157  
 Denon 0147  
 Disco Vision 0017  
 Funai 0157  
 Hitachi (E) 0017  
 Kenwood 0087, 0107  
 Magnavox 0027  
 Marantz 0027  
 Mitsubishi 0137  
 NAD 0137  
 Panasonic 0077, 0177  
 Philips 0027  
 Pioneer 0037, 0017, 0137  
 RCA 0167  
 Realistic 0157  
 Sharp 0127  
 Sony 0047, 0057, 0117  
 Victor 0097  
 Yamaha 0007, 0067

## CD PLAYER

Acoustic Research 1295  
 ADC 0025, 0065  
 Adcom 0205, 0255, 1015  
 ADS 0265  
 Aiwa 0295, 0945, 1035, 1055  
 Akai 0175, 0485, 0535  
 Alpine 1215, 1305  
 Audio-Technica 0545  
 BSR 0245, 0655, 0775  
 California Audio Lab 0055  
 Capetronic 1205  
 Carrera 0245  
 Carver 0285, 1135  
 Casio 0345  
 Crown 0185  
 Curtis Maths 0345  
 Denon 0275, 0875, 0885  
 Deual (E) 0505

Dynamic Bass (H) 0555  
 Emerson 0205, 0325, 1105  
 Eroica 1275  
 Fisher 0095, 0555, 0925, 1005  
 Garrard 0365  
 Genexxa 0305, 0325, 1105  
 GoldStar 1225, 1265, 1135, 1335  
 H/K 0105, 0175, 0465, 0995  
 Hitachi 0195, 0505, 0205, 0815  
 Inkel 0115, 0395  
 JVC 0315  
 Kenwood 0045, 0095, 0405,  
 0585, 0725, 0735,  
 0745, 0755, 0895  
 Kyocera 0025  
 Luxman 0075, 0425, 0675,  
 0705, 0715, 0985  
 Magnavox 0165, 0215, 0645, 0955  
 Marantz 0215, 0235, 0375, 0785, 1345  
 McIntosh 0355, 1085  
 MCS 0905, 1315  
 Memorex 0205, 0225, 0235,  
 0305, 0325, 1105  
 MGA 0135  
 Mission 0215  
 Mitsubishi 0135, 0445  
 MTC 1255  
 NAD 0035, 0615, 0685, 0695  
 Nakamichi 0125, 0435, 0515  
 NEC 0255, 0905, 0965  
 Nikko 0545, 1005  
 Onkyo 0155, 0455, 0495, 0805, 1155  
 Optimus 0225, 0245, 0555, 0595,  
 0845, 0855, 0865,  
 0895, 0935  
 Panasonic 0055, 0825, 1095, 1125  
 Penny 0905  
 Philips 0165, 0215  
 Pioneer 0305, 0935, 1045  
 Proton 0215, 1185  
 Quasar 0055  
 RCA 0205, 0915, 1115  
 Realistic 0205, 0225, 0235,  
 0325, 0555, 0845  
 Revox 1175  
 Rotel 0215  
 Saba Telecommander (E) 0505  
 SAE 0215  
 Samsung 1285  
 Sansui 0215, 0625, 0975, 1025, 1105  
 Sanyo 0145, 0555, 0635, 0765  
 Scott 0325, 1105  
 Sears 0345  
 Sharp 0235, 0665, 0895, 1065, 1075  
 Sherwood 0115, 0235, 0395, 0475  
 Siemants Garrard 1245  
 Signature 0175  
 Sontec 1165

Sony	0065, 0565, 0865, 1145
Staron	1235
STS	0025
Sylvania	0215
Symphonic	0335
Tandy	0305
Tangberg	1195
Teac	0235, 0335, 0385, 0525, 0795, 0835, 1355
Technics	0055, 0605, 1095
Techwood	1325
Telefunken (E)	0505
Thomson (E)	0505
Toshiba	0035, 0685
Vector Research	0065, 1135
Victor	0315
Wards	0175
Yamaha	0005, 0015, 0575, 1065

---

## MD RECORDER

Yamaha	0024
--------	------

---

## TAPE DECK

Aiwa	0094, 0214, 0224
Akai	0184
Carver	0094
Denon	0304
Fisher	0144
Garrard	0194, 0204
JVC	0274, 0284, 0294
Kenwood	0124, 0134, 0154, 0234, 0244, 0264
Magnavox	0094
Marantz	0094, 0344
Mitsubishi	0184
Onkyo	0364, 0374
Optimus	0034, 0064, 0204, 0334
Philips	0094
Pioneer	0034, 0044, 0064
Revox	0354
Sansui	0094, 0344
Sharp	0264
Sherwood	0334
Sony	0054, 0084, 0324
Teac	0194, 0254
Technics	0074, 0314
Victor	0294
Wards	0034
Yamaha	0004, 0014



---

**YAMAHA ELECTRONICS CORPORATION, USA** 6660 ORANGETHORPE AVE., BUENA PARK, CALIF. 90620, U.S.A.  
**YAMAHA CANADA MUSIC LTD.** 135 MILNER AVE., SCARBOROUGH, ONTARIO M1S 3R1, CANADA  
**YAMAHA ELECTRONIK EUROPA G.m.b.H.** SIEMENSSTR. 22-34, 25462 RELLINGEN BEI HAMBURG, F.R. OF GERMANY  
**YAMAHA ELECTRONIQUE FRANCE S.A.** RUE AMBROISE CROIZAT BP70 CROISSY-BEAUBOURG 77312 MARNE-LA-VALLEE CEDEX02, FRANCE  
**YAMAHA ELECTRONICS (UK) LTD.** YAMAHA HOUSE, 200 RICKMANSWORTH ROAD WATFORD, HERTS WD1 7JS, ENGLAND  
**YAMAHA SCANDINAVIA A.B.** J A WETTERGRENS GÅTA 1, BOX 30053, 400 43 VÄSTRA FRÖLUNDA, SWEDEN  
**YAMAHA MUSIC AUSTRALIA PTY, LTD.** 17-33 MARKET ST., SOUTH MELBOURNE, 3205 VIC., AUSTRALIA

**YAMAHA CORPORATION**  
Printed in Malaysia ID V343260



# Quick Reference Card

## AMP<TUNER>

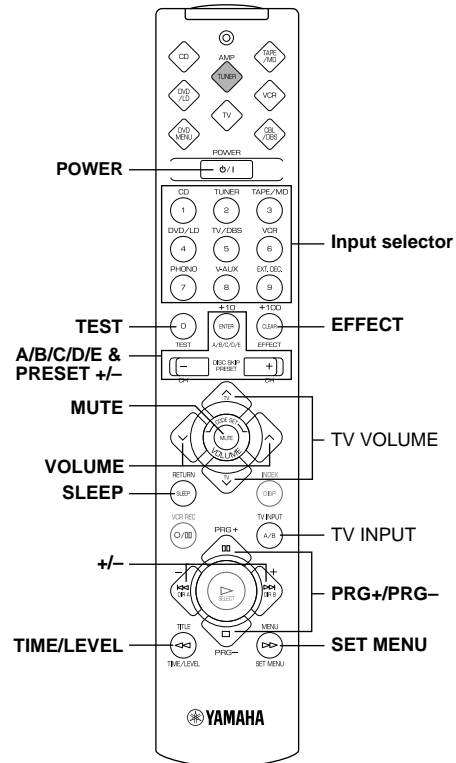

## TAPE/MD

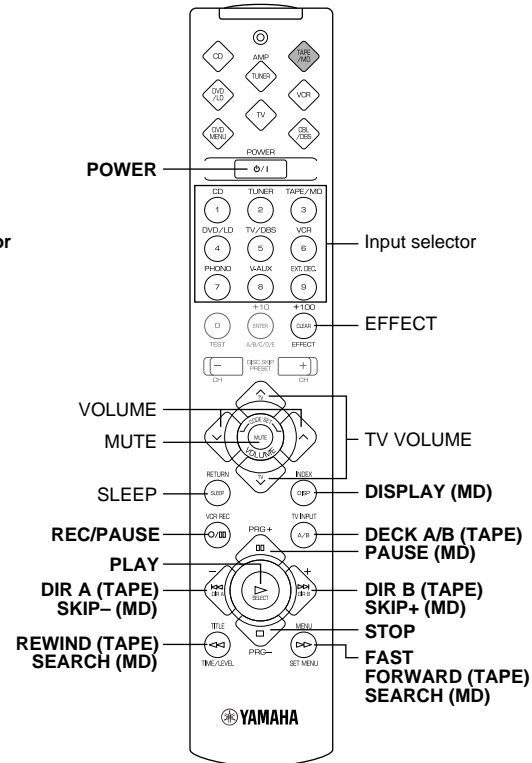

## CD

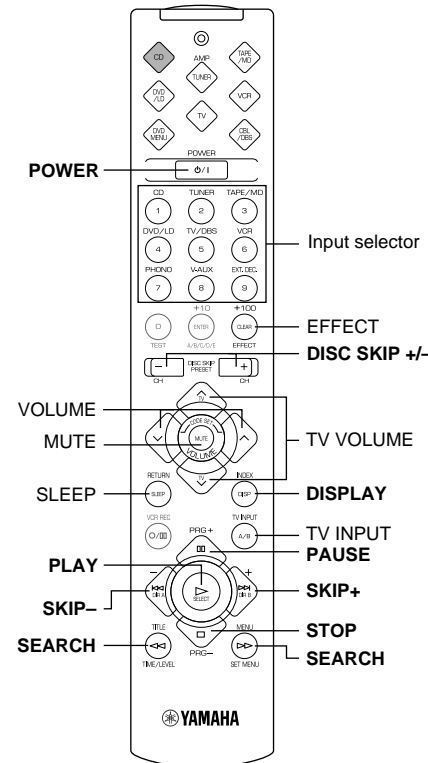

## DVD/LD

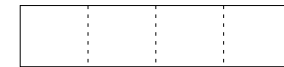
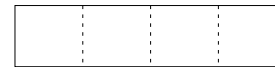
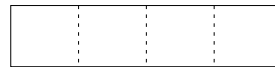
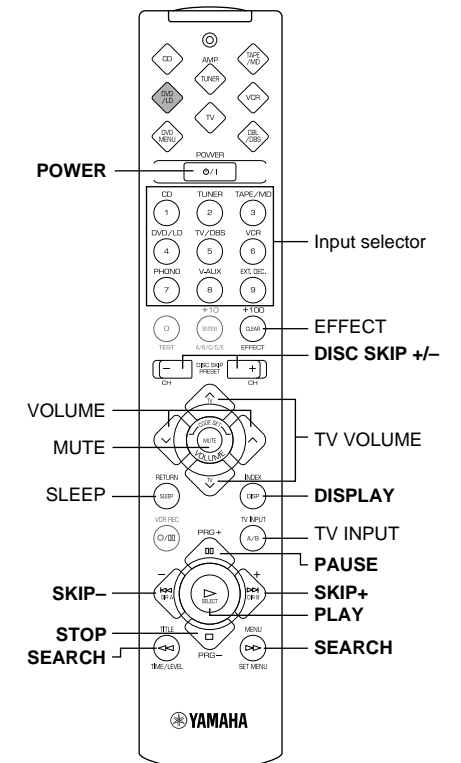

# Quick Reference Card

DVD MENU		VCR		CBL/DBS		TV	
POWER		VCR POWER		CBL/DBS POWER		TV POWER	
		CHANNEL		CHANNEL		CHANNEL	
	Numeric buttons						
			EFFECT CHANNEL ENTER		+100 CHANNEL ENTER		EFFECT CHANNEL ENTER
DISC SKIP +/-		VCR CHANNEL +/-		CBL/DBS CHANNEL +/-		TV CHANNEL +/-	
VOLUME		VOLUME		VOLUME		VOLUME	
MUTE	TV VOLUME	MUTE	TV VOLUME	MUTE	TV VOLUME	TV MUTE	TV VOLUME
RETURN	INDEX	TV SLEEP	DISPLAY	TV SLEEP	DISPLAY	TV SLEEP	DISPLAY
MENU UP	TV INPUT	VCR REC (*1)	VCR PAUSE	MENU UP	TV INPUT	VCR REC (*1)	TV INPUT
MENU LEFT	MENU RIGHT	VCR PLAY	VCR STOP	MENU LEFT	MENU RIGHT	VCR PLAY	VCR STOP
MENU SELECT	MENU DOWN	VCR REWIND	VCR FAST FORWARD	MENU SELECT	MENU DOWN	VCR REWIND	VCR FAST FORWARD
TITLE	MENU			RECALL	MENU		

\*1: Press this button twice to start recording.  
 Appuyer deux fois sur cette touche pour lancer l'enregistrement.  
 Diese Taste zweimal drücken, um die Aufnahme zu starten.  
 Tryck två gånger på den här knappen för att börja spela in på videobandspelaren.

Premere due volte questo tasto per iniziare la registrazione.  
 Presione dos veces este botón para comenzar a grabar.  
 Druk tweemaal op deze toets om te beginnen met opnemen.  
 按两次该按钮即可开始录像。